

6605 - Techno System - semi-spherical diffuser wide beam - CRI 90

Code: 133052-00

GENERAL INFORMATION

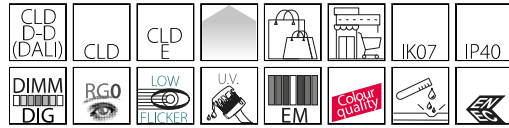

Article	6605 - Techno System - semi-spherical diffuser wide beam - CRI 90
Code	133052-00

DIMENSIONS AND WEIGHT

Length (mm)	1421 mm
Width (mm)	60 mm
Height (mm)	52 mm
Weight (Kg)	1.6 kg

ELECTRICAL CHARACTERISTICS AND CONTROLS

Voltage type	AC
Min Voltage (V)	220 V
Max Voltage (V)	240 V
Min Frequency (Hz)	50 Hz
Max Frequency (Hz)	60 Hz
Frequency (Hz)	50 Hz
Wiring name	CLD
Power factor	≥0.95
Insulation class	Class I
Controllability	None



Its simple, modern design blends perfectly into any space. It is 1421-mm long (but can be requested in 575/1139/1703/2267/2831/3395 mm), and comes in many versions.

The new Techno System has a wide range of optics with different LEDs. This makes it possible to select the most suitable luminaire for any design while achieving the required light levels at lower energy consumption.



6605 - Techno System - semi-spherical diffuser wide beam - CRI 90

Code: 133052-00

PHOTOMETRIC DATA

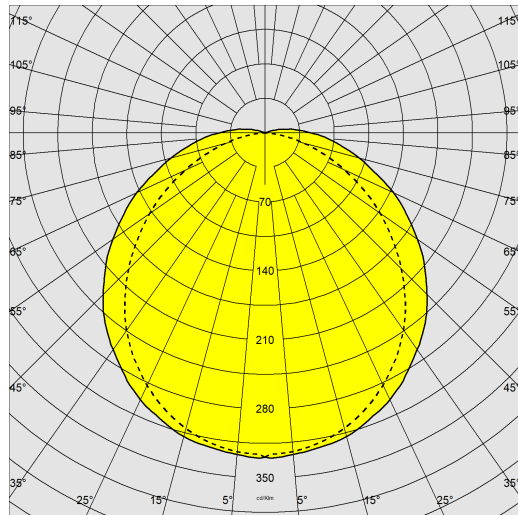

Lighting source	LED
CRI	90
Luminous flux (output) (lm)	3415 lm
Power absorption (total) (W)	34 W
CCT	4000 K
Luminous efficacy (lm/W)	100 lm/W
Low Flicker	luminaire with very low flicker: evenly distributed light for greater visual safety.
LED flux maintenance	30000 hr, L 90, B 10

MECHANICAL CHARACTERISTICS

Impact resistance rating (IK)	IK07
IP	40



6605 - Techno System - semi-spherical diffuser wide beam - CRI 90

Code: 133052-00

MATERIALS AND COLOURS

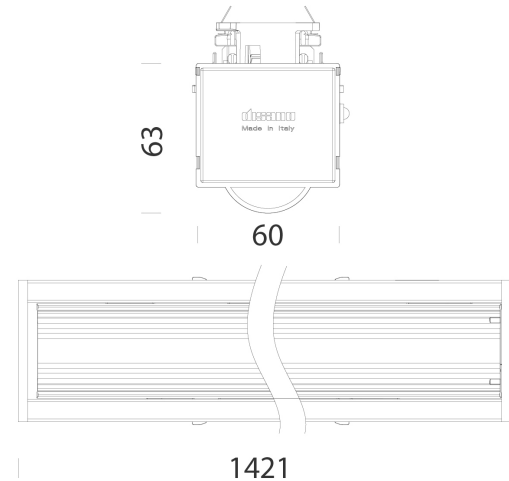

DOWNLOAD

MOUNTS

[AssemblyInstructions techno system 01-23.pdf](#)

DESIGNS

[BIM 6605 Techno System - wide-beam semi-spherical diffuser - CRI 90 - 20200611.zip](#)

[TechnicalDrawing 6616.dxf](#)

[TechnicalDrawing3D disano 6605 TechnoSystem.3ds](#)



Housing	in galvanized rolled steel, with anti-cutting turned-up edges and ABS end caps.
Diffuser	semi-spherical in polycarbonate, transparent, grooved for greater light control, V2 self-extinguishing, UV stabilised.
Coating	pre-painted in oven with polyester resin, UV-stabilised, phosphate pre-treatment.
Colour	White
Equipment	designed as standard for 5-pole, 7-pole (EMergency or DIMMerable DALI versions) and 11-pole (EMergency and DIMMerable DALI versions) wiring. External fastening system for attachment to the channel.

STANDARDS AND COMPLIANCE

Photobiological safety class	RG0
Markings and tests	CE, ENEC
Reference standards	EN60598-1. With degree of protection according to EN60529. The lighting fixture meets all IFS and BRC requirements, and the regulation of the HACCP Directive regarding lighting systems installed in food processing plants.
Energy Label	C

GEAR

Upon request	<ul style="list-style-type: none"> - phase selector switch with up to 11 conductors - 3000K-6500K versions - versions for FOOD industry (Red Meat, Marbled Meat, Fish, Bread, Pastries and Produce) - CLD-EC wiring for centrally powered emergency lighting, subcode -0050
--------------	---

WARRANTY

After sales warranty	5 yr
----------------------	------

6605 - Techno System - semi-spherical diffuser wide beam - CRI 90

Code: 133052-00

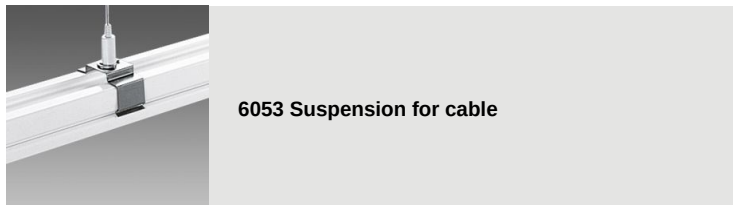
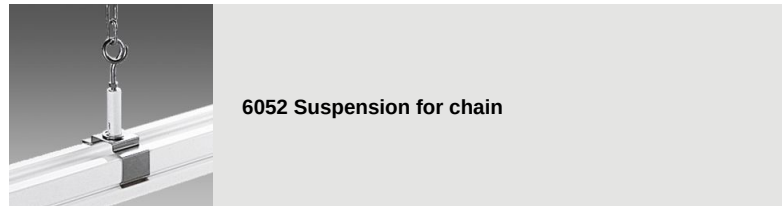
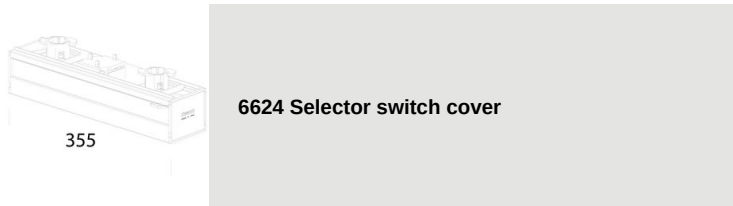
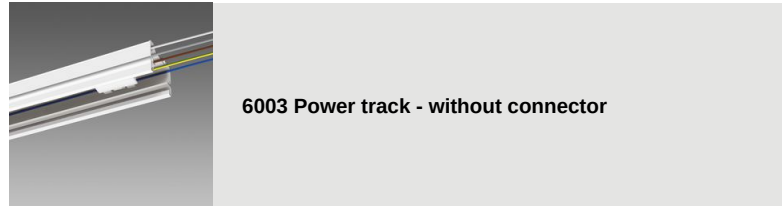
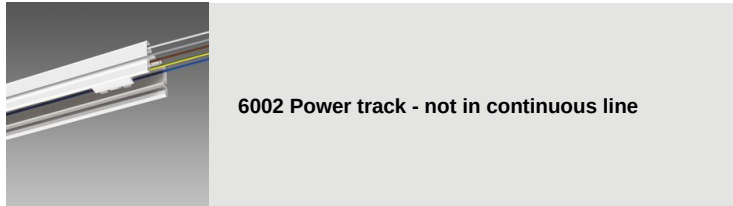

6605 - Techno System - semi-spherical diffuser wide beam - CRI 90

Code: 133052-00

