

3479 - Mini Giovi T4 - large areas

Code: 331041-00

GENERAL INFORMATION

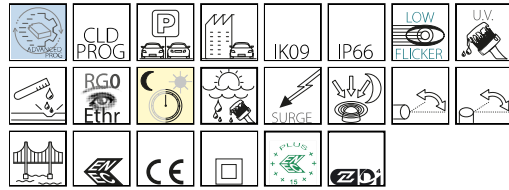

Article	3479 - Mini Giovi T4 - large areas
Code	331041-00

DIMENSIONS AND WEIGHT

Length (mm)	558 mm
Width (mm)	293 mm
Height (mm)	115 mm
Weight (Kg)	6.2 kg

INSTALLATION

Diameter (Ø) of pole connector (mm)	46-76 mm
Surface exposed to wind (mm)	L 49500 mm ² , F 155100 mm ²

ELECTRICAL CHARACTERISTICS AND CONTROLS

Voltage type	AC
Min Voltage (V)	220 V
Max Voltage (V)	240 V
Min Frequency (Hz)	50 Hz
Max Frequency (Hz)	60 Hz
Frequency (Hz)	50 Hz
Wiring name	CLD
Power factor	≥0.9
Rated Current	700 mA
Surge protector (common) (EN 61547)	6 kV, 10 kV
Insulation class	Class II
Controllability	None



Mini Giovi represents the latest generation of LED street lamps designed to fit the new light sources and the most advanced lighting control and management systems. Its housing in die-cast aluminium offers very little resistance to wind with its cooling fins specifically studied to allow optimal heat dissipation and efficient LED operation.



3479 - Mini Giovi T4 - large areas

Code: 331041-00

PHOTOMETRIC DATA

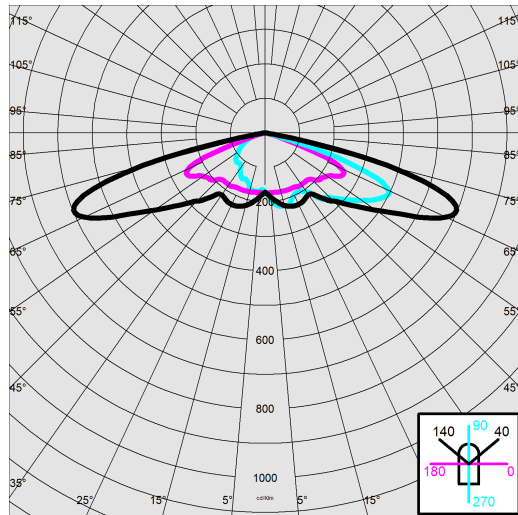

Distribution type	Asymmetric
Lighting source	LED
CRI	70
Luminous flux (output) (lm)	10512 lm
Power absorption (total) (W)	67 W
CCT	4000 K
Luminous efficacy (lm/W)	157 lm/W
Low Flicker	luminaire with very low flicker: evenly distributed light for greater visual safety.
LED flux maintenance	100000 hr, L 90, B 10

MECHANICAL CHARACTERISTICS

Impact resistance rating (IK)	IK09
IP	66
Ambient temperature - min	-30 °C
Ambient temperature - max	50 °C

3479 - Mini Giovi T4 - large areas

Code: 331041-00

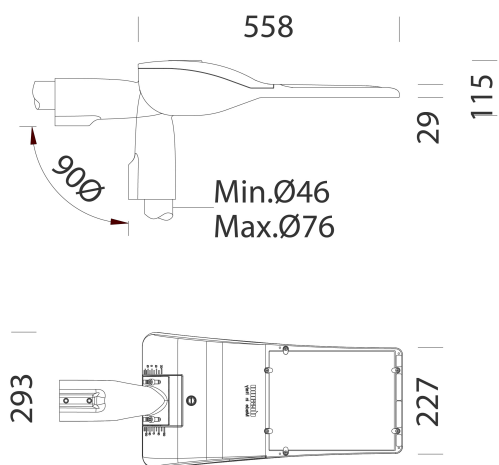

DOWNLOAD

MOUNTS

[AssemblyInstructions giovi - minigiovi 09-22.pdf](#)

DESIGNS

[BIM 3479 MiniGiovi T4 - 04-24.zip](#)

[TechnicalDrawing minigiovi.dxf](#)



MATERIALS AND COLOURS

Housing	EN-AB 47100 die-cast aluminium and designed with a very small surface exposed to wind. Cooling fins integrated in the cover. The lid can be removed to access the electrical components.
Optics	in high-performance PMMA resistant to high temperatures and UV rays.
Diffuser	extra-clear, tempered glass, 4 mm thick, resistant to thermal shock and impact (UNI-EN 12150-1:2001).
Heat sink	the heat sink is designed and made to allow the LEDs to operate at temperatures capable of ensuring excellent performance/output and long service life.
Pole connection	in die-cast aluminium for poles with a diameter between min. 46 mm and max. 76 mm, adjustable from -20° to +10° for side-mount applications; and from 0° to +20° for top-mount applications. Tilt pitch 5°.
Coating	the fully automated powder-coating cycle involves a polyester-based, salt-spray corrosion-resistant and UV-stabilised paint.
Special coating (UPON REQUEST)	Upon request: protective coating recommended for marine environments within 5 km (3 miles) of the sea.
Colour	Graphite
Equipment	<ul style="list-style-type: none"> - waterproof connector for quick installation with no need to open the fixture. - anti-condensation valve. - temperature controller with auto-reset. - EN 61547 compliant surge protection. - ADVANCED PROG built-in functions.

STANDARDS AND COMPLIANCE

Photobiological safety class	RG0 Ethr
Markings and tests	CE, ENEC+, ZHAGA D4i, ENEC
Reference standards	EN60598-1. With degree of protection according to EN60529. Registered Design DM/100271.
Laboratory Tests	compliant with third-party certified vibration tests pursuant to ANSI C136.31: Street Lighting - Luminaire Vibration. Test level: 3.0G Level 2 for bridge/overpass applications.
Energy Label	C

GEAR

Upon request	<ul style="list-style-type: none"> - virtual midnight device, subcode -30 - Nema Socket, subcode -40 (cap to be ordered separately) - Zhaga Socket, subcode -0054 (cap included)
--------------	---

WARRANTY

After sales warranty	5 yr
----------------------	------

3479 - Mini Giovi T4 - large areas

Code: 331041-00

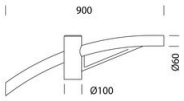

504 Single arm



508 Double arm



1491 Pole to be buried



1493 Pole with base



1477 Urban Pole - with base



1478 Urban Pole to be buried



1508 Fluted pole Ø 120 with base



1509 Fluted pole Ø 120