

## 1999 - Mini Rodio - COB symmetric

Code: 414841-39

### GENERAL INFORMATION

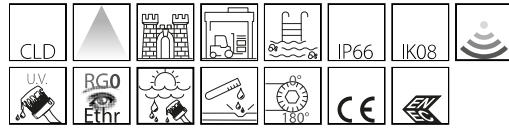

Article	1999 - Mini Rodio - COB symmetric
Code	414841-39

### DIMENSIONS AND WEIGHT

Length (mm)	400 mm
Width (mm)	273 mm
Height (mm)	70 mm
Weight (Kg)	3 kg

### INSTALLATION

Surface exposed to wind (mm)	L 24200 mm <sup>2</sup> , F 80700 mm <sup>2</sup>
------------------------------	---

### ELECTRICAL CHARACTERISTICS AND CONTROLS

Voltage type	AC
Min Voltage (V)	220 V
Max Voltage (V)	240 V
Min Frequency (Hz)	50 Hz
Max Frequency (Hz)	60 Hz
Frequency (Hz)	50 Hz
Wiring name	CLD
Power factor	≥0.9
Insulation class	Class I
Controllability	None



Within the range of floodlights, an excellent technological result has been achieved with the new Mini Rodio from the Rodio series. The small dimensions of this luminaire allow it to be inserted into any architecture or setting, for an aesthetic and high-tech lighting project. It is available in many versions with symmetric or asymmetric lenses, and also in a version with COB LEDs.

The excellent performance of this floodlight in terms of energy savings and luminous efficiency is accompanied by a long lifespan of 50/80,000 hours; furthermore, the use of materials with IP66 protection makes the Mini Rodio perfectly suitable for outdoor installations.

These spotlights are characterised by better light quality and a long lifespan, both guaranteed by the best possible materials and the most advanced LED sources.



## 1999 - Mini Rodio - COB symmetric

Code: 414841-39

### PHOTOMETRIC DATA

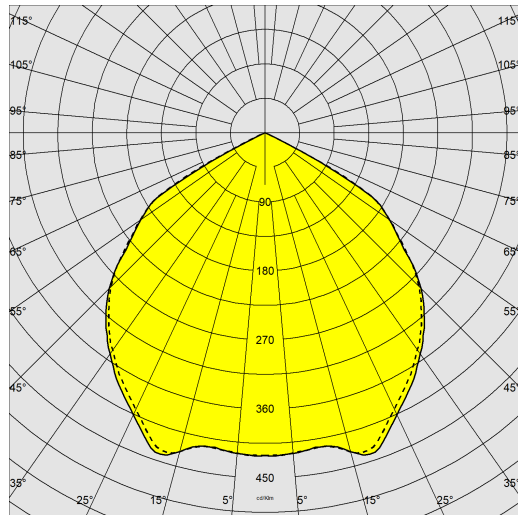

Lighting source	LED COB
CRI	80
Luminous flux (output) (lm)	7771 lm
Power absorption (total) (W)	54 W
CCT	3000 K
Luminous efficacy (lm/W)	144 lm/W
Low Flicker	luminaire with very low flicker: evenly distributed light for greater visual safety.
LED flux maintenance	50000 hr, L 80, B 20

### MECHANICAL CHARACTERISTICS

Impact resistance rating (IK)	IK08
IP	66
Ambient temperature - min	-20 °C
Ambient temperature - max	40 °C

## 1999 - Mini Rodio - COB symmetric

Code: 414841-39

### MATERIALS AND COLOURS

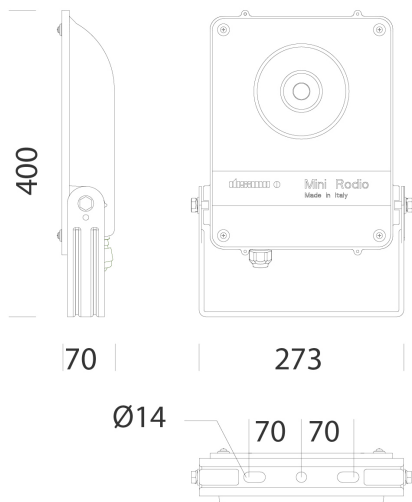

### DOWNLOAD

#### MOUNTS

[AssemblyInstructions mini rodio 12-23.pdf](#)

#### DESIGNS

[TechnicalDrawing 1999w.dxf](#)

[TechnicalDrawing3D disano 1999 minirodio.3ds](#)



Housing	in die-cast aluminium with cooling fins integrated in the cover.
Optics	anodised and polished 99.85 aluminium.
Diffuser	tempered glass, 4 mm thick, resistant to thermal shock and impact (UNI EN 12150-1:2001).
Heat sink	the heat sink is designed and made to allow the LEDs to operate at temperatures capable of ensuring excellent performance/output and long service life.
Coating	pre-treatment of metal surface, polyester powder coating to ensure resistance to corrosion and salt spray fogs, UV stabilised.
Special coating (UPON REQUEST)	upon request: available with coating tested to withstand corrosion tests in aggressive artificial atmospheres (UNI EN ISO 9227) or marine environments (sea front).
Colour	Graphite
Equipment	<ul style="list-style-type: none"> <li>- with galvanised and painted bracket</li> <li>- cable for electrical connection</li> <li>- EN 61547 compliant surge protection</li> <li>- silicone rubber gasket</li> <li>- external screws and bolts in stainless steel.</li> </ul>

### STANDARDS AND COMPLIANCE

Photobiological safety class	RG0 Ethr
Markings and tests	CE, ENEC
Reference standards	EN60598-1. With degree of protection according to EN60529.
Energy Label	D

### GEAR

Upon request	<ul style="list-style-type: none"> <li>- protection of up to 10kV.</li> <li>- amber LED (subcode -73 - 2200K)</li> <li>- CLD-D-D (DALI) wiring (subcode -0041)</li> <li>- possibility of central light management or with external presence/light sensors.</li> </ul>
--------------	---

### WARRANTY

After sales warranty	5 yr
----------------------	------

## 1999 - Mini Rodio - COB symmetric

Code: 414841-39



**333 Connection for diam. 60 pole**

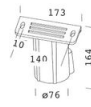

**334 Connection for diam. 76 pole**

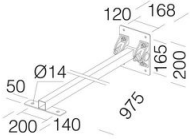

**42 Adjustable arm**