

1980 - Micro Rodio - COB

Code: 414865-39

GENERAL INFORMATION

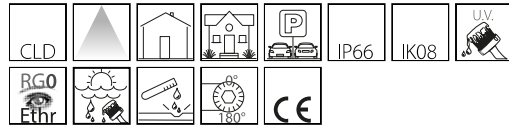

Article	1980 - Micro Rodio - COB
Code	414865-39

DIMENSIONS AND WEIGHT

Length (mm)	145 mm
Width (mm)	45 mm
Height (mm)	227 mm
Weight (Kg)	1.1 kg

INSTALLATION

Surface exposed to wind (mm)	L 8600 mm ² , F 27800 mm ²
------------------------------	--

ELECTRICAL CHARACTERISTICS AND CONTROLS

Voltage type	AC
Min Voltage (V)	220 V
Max Voltage (V)	240 V
Min Frequency (Hz)	50 Hz
Max Frequency (Hz)	60 Hz
Frequency (Hz)	50 Hz
Wiring name	CLD
Power factor	≥0.9
Surge protector (common) (EN 61547)	1 kV, 2 kV
Insulation class	Class I
Controllability	None
Integrated Function	-



To meet the needs of those lighting projects where the size of the fixture makes the difference, Disano has created Micro Rodio, the floodlight that concentrates all the technology of the Rodio family into extremely compact dimensions. Also available with COB LED for a greater lighting quality, it stands out for a very long lamp life thanks to top quality materials and LED sources.



1980 - Micro Rodio - COB

Code: 414865-39

PHOTOMETRIC DATA

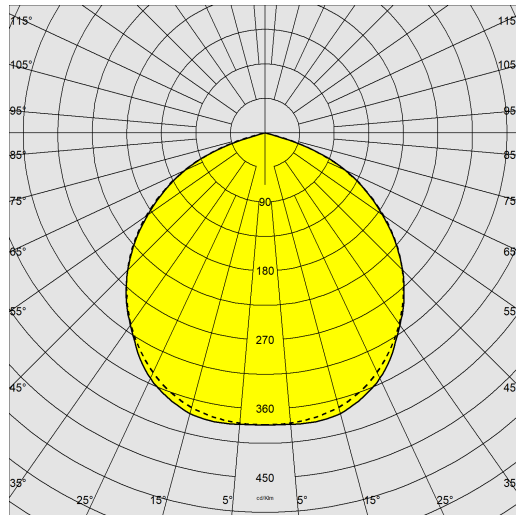

Lighting source	LED COB
CRI	80
Luminous flux (output) (lm)	3289 lm
Power absorption (total) (W)	38 W
CCT	3000 K
Luminous efficacy (lm/W)	87 lm/W
Low Flicker	luminaire with very low flicker: evenly distributed light for greater visual safety.
LED flux maintenance	50000 hr, L 80, B 20

MECHANICAL CHARACTERISTICS

Impact resistance rating (IK)	IK08
IP	66
Ambient temperature - min	-20 °C
Ambient temperature - max	40 °C

1980 - Micro Rodio - COB

Code: 414865-39

MATERIALS AND COLOURS

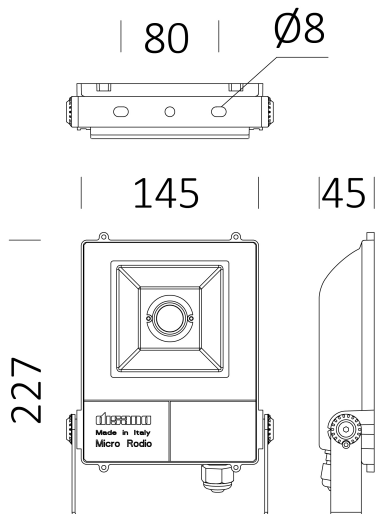

DOWNLOAD

MOUNTS

[AssemblyInstructions microrodio 09-22.pdf](#)

DESIGNS

[TechnicalDrawing 1980.dxf](#)

[TechnicalDrawing3D disano 1980 microrodio.3ds](#)



Housing	in die-cast aluminium with cooling fins integrated in the cover.
Optics	in high-performance prismatic and polished aluminium.
Diffuser	tempered glass, 4 mm thick, resistant to thermal shock and impact (UNI EN 12150-1:2001).
Heat sink	the heat sink is designed and made to allow the LEDs to operate at temperatures capable of ensuring excellent performance/output and long service life.
Coating	the fully automated powder-coating cycle involves a polyester-based, salt-spray corrosion-resistant and UV-stabilised paint.
Special coating (UPON REQUEST)	Upon request: protective coating recommended for marine environments within 5 km (3 miles) of the sea.
Colour	Graphite
Equipment	<ul style="list-style-type: none"> - with galvanised and painted bracket - cable for electrical connection - EN 61547 compliant surge protection - silicone rubber gasket - external screws and bolts in stainless steel.

STANDARDS AND COMPLIANCE

Photobiological safety class	RG0 Ethr
Markings and tests	CE
Reference standards	EN60598-1. They have a degree of protection according to the EN60529 standard.
Energy Label	E

GEAR

Upon request	<ul style="list-style-type: none"> - version with presence sensor (subcode -19) - double insulation (subcode -14) - CLD-D-D (DALI) wiring (subcode -0041)
--------------	--

WARRANTY

After sales warranty	5 yr
----------------------	------

1980 - Micro Rodio - COB

Code: 414865-39

