

1564 - Elfo Amber - FS

Code: 422397-73

GENERAL INFORMATION

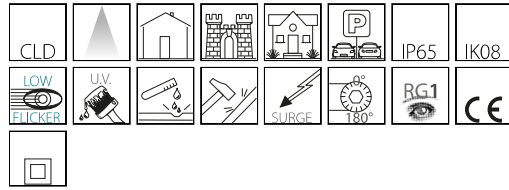

Article	1564 - Elfo Amber - FS
Code	422397-73

DIMENSIONS AND WEIGHT

Length (mm)	200 mm
Width (mm)	150 mm
Height (mm)	300 mm
Diameter (Ø) (mm)	150 mm
Weight (Kg)	2.6 kg

ELECTRICAL CHARACTERISTICS AND CONTROLS

Voltage (V)	230 V
Frequency (Hz)	50 Hz
Wiring	CLD
Power factor	≥0.9
Insulation class	Class II
Controllability	None

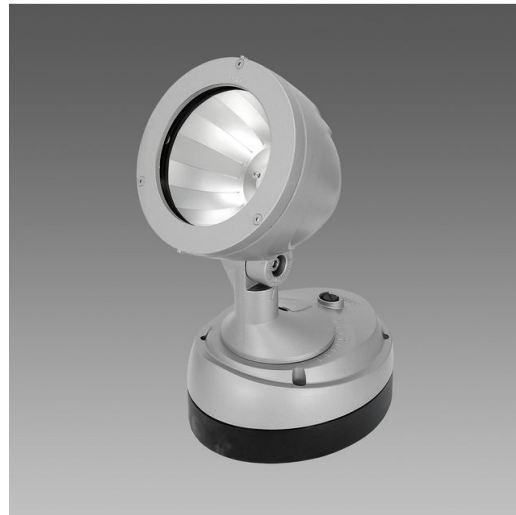

A complete product that meets needs and wishes of lighting designers.



1564 - Elfo Amber - FS

Code: 422397-73

PHOTOMETRIC DATA

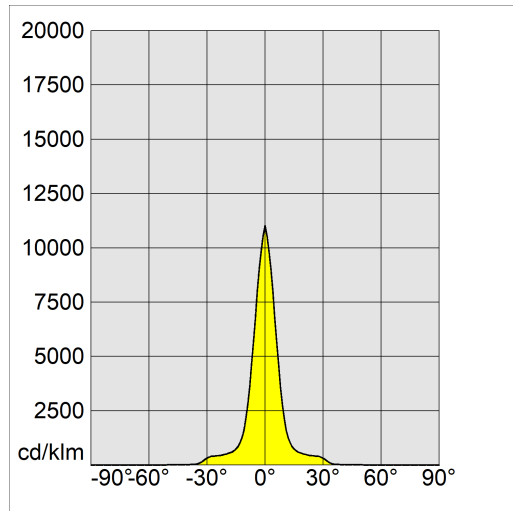

Lighting source	LED AMBER
CRI	amber
Luminous flux (output) (lm)	2373 lm
Power absorption (total) (W)	28 W
CCT	2200 K
Luminous efficacy (lm/W)	85 lm/W
Beam angle (°)	15 °
LED flux maintenance	50000 hr, L 80, B 20

MECHANICAL CHARACTERISTICS

Impact resistance rating (IK)	IK08
IP	65



1564 - Elfo Amber - FS

Code: 422397-73

MATERIALS AND COLOURS

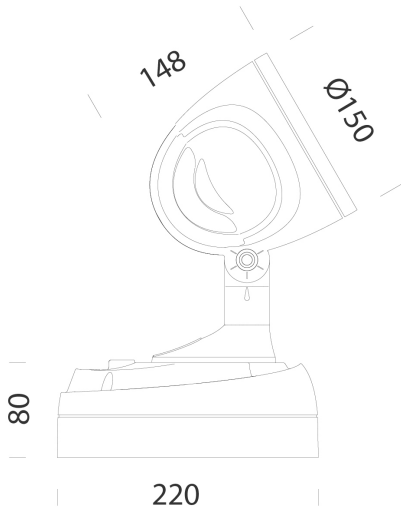

DOWNLOAD

MOUNTS

[AssemblyInstructions Elfo 03-23.pdf](#)

DESIGNS

[TechnicalDrawing elfoled.dxf](#)



Housing	in die-cast aluminium with cooling fins integrated in the cover.
Optics	in high-performance silver-coated aluminium.
Diffuser	tempered glass, 4 mm thick, resistant to thermal shock and impact (UNI EN 12150-1:2001).
Coating	pre-treatment of metal surface, polyester powder coating to ensure resistance to corrosion and salt spray fogs, UV stabilised.
Colour	Graphite
Equipment	silicone and EPDM rubber sealing gasket. Rubber cable gland Ø 1/2 gas inch.

STANDARDS AND COMPLIANCE

Photobiological safety class	RG0 Ethr
Markings and tests	CE
Reference standards	EN60598-1. With degree of protection according to EN60529.
Energy Label	E

WARRANTY

After sales warranty	3 yr
----------------------	------

1564 - Elfo Amber - FS

Code: 422397-73

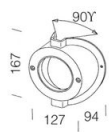

116 Angle support

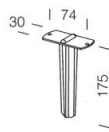

119 Spike

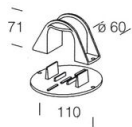

120 Pole support

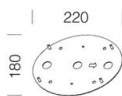

188 Board