

2569 - Podio - with reflector

Code: 422572-39

GENERAL INFORMATION

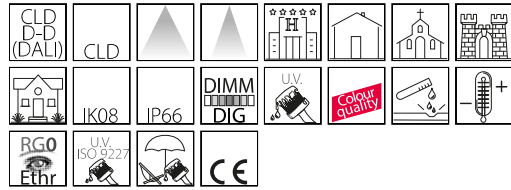

Article	2569 - Podio - with reflector
Code	422572-39

DIMENSIONS AND WEIGHT

Height (mm)	236 mm
Diameter (Ø) (mm)	160 mm
Weight (Kg)	1.5 kg

ELECTRICAL CHARACTERISTICS AND CONTROLS

Voltage type	AC
Min Voltage (V)	220 V
Max Voltage (V)	240 V
Min Frequency (Hz)	50 Hz
Max Frequency (Hz)	60 Hz
Frequency (Hz)	50 Hz
Wiring name	CLD
Power factor	≥0.92
Insulation class	Class I
Controllability	None



Podio, the new addition to the range of spotlights/residential lights, bears the designer signature of Alessandro Pedretti. Made in Italy quality is the distinctive feature of this spotlight which is also seen in the combination between aesthetics and functionality. Podio, in fact, can be used both outdoors, especially in gardens and parks, and indoors to always guarantee an excellent result in terms of energy savings and light quality. The most advanced technology, the colour of the LED light and the excellent performance allow Podio to set itself as the ideal spotlight in any architectural setting.

Thanks to technological evolution and the use of LEDs it is possible to enhance historical monuments or new infrastructure with non invasive systems and that do not alter the viewing of colours and of materials. This will allow the correct illumination and enhancement of cultural assets and landmarks that represent the identity of a place.

The advanced technology and improved design are conceived to reduce power consumption and replace obsolete fixtures in order to meet the growing need for energy savings.



2569 - Podio - with reflector

Code: 422572-39

PHOTOMETRIC DATA

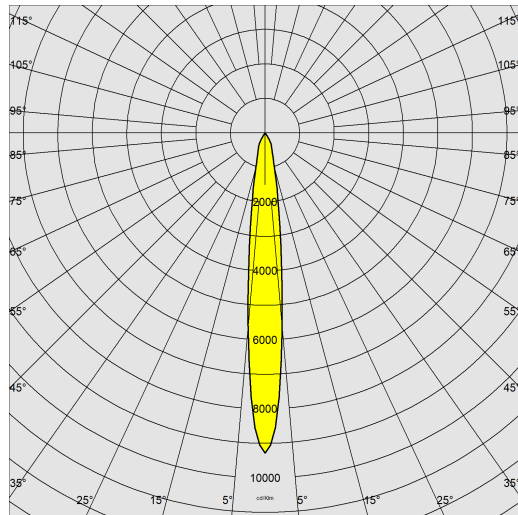

Lighting source	LED COB
CRI	80
Luminous flux (output) (lm)	4253 lm
Power absorption (total) (W)	40 W
CCT	3000 K
Luminous efficacy (lm/W)	106 lm/W
Beam angle	13 °
LED flux maintenance	50000 hr, L 80, B 20

MECHANICAL CHARACTERISTICS

Impact resistance rating (IK)	IK08
IP	66



2569 - Podio - with reflector

Code: 422572-39

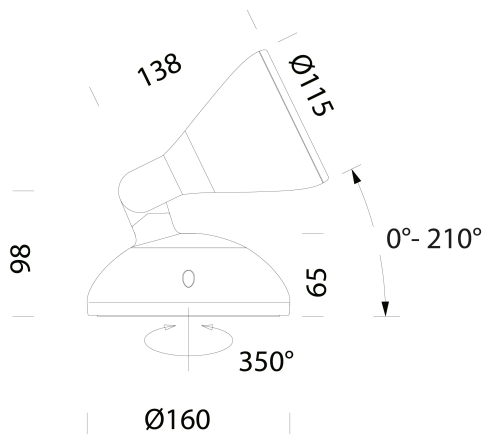

DOWNLOAD

MOUNTS

[AssemblyInstructions Podio 09-22.pdf](#)

DESIGNS

[TechnicalDrawing 2569.dxf](#)

[TechnicalDrawing3D disano 2569 podio.3ds](#)



MATERIALS AND COLOURS

Housing	die-cast aluminium, with central die-cast aluminium joint.
Optics	in high-performance silver-coated aluminium.
Diffuser	extra-clear, tempered glass, 4 mm thick, resistant to thermal shock and impact (UNI-EN 12150-1:2001).
Coating	pre-treatment of metal surface, polyester powder coating, resistance to corrosion, UV stabilised. Standard with coating for marine environments in compliance with UNI EN ISO 9227.
Colour	Grey
Equipment	with surge protection in compliance with EN 61547 to protect the LED module and the related ballast.

STANDARDS AND COMPLIANCE

Photobiological safety class	RG0 Ethr
Markings and tests	CE
Reference standards	EN60598-1. With degree of protection according to EN60529.
Energy Label	E

GEAR

Upon request	1/10 DIMM or DALI versions.
--------------	-----------------------------

WARRANTY

After sales warranty	3 yr
----------------------	------