

## 1513 - Torcia LED COB

Code: 423250-0016

### GENERAL INFORMATION



Article	1513 - Torcia LED COB
Code	423250-0016

### DIMENSIONS AND WEIGHT

Length (mm)	375 mm
Width (mm)	375 mm
Height (mm)	765 mm
Weight (Kg)	7.4 kg

### INSTALLATION

Diameter (Ø) of pole connector (mm)	60-60 mm
Surface exposed to wind (mm)	L 165000 mm <sup>2</sup> , F 165000 mm <sup>2</sup>

### ELECTRICAL CHARACTERISTICS AND CONTROLS

Voltage type	AC
Min Voltage (V)	220 V
Max Voltage (V)	240 V
Min Frequency (Hz)	50 Hz
Max Frequency (Hz)	60 Hz
Frequency (Hz)	50 Hz
Wiring name	CLD
Power factor	≥0.9
Surge protector (common) (EN 61547)	10 kV, 10 kV
Insulation class	Class II
Controllability	None

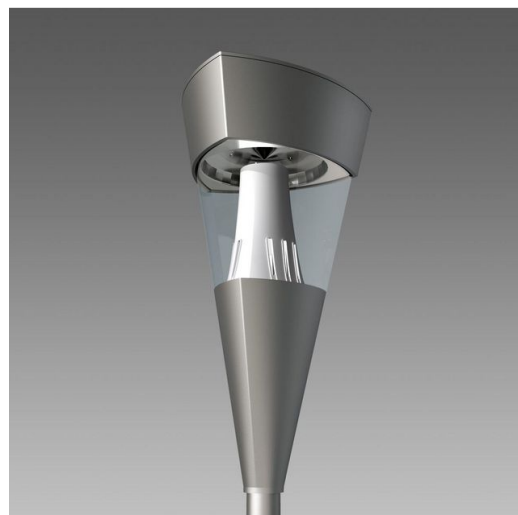

Torcia with the new LED sources guarantees high lighting quality and with the unique reflector cone allows optimal light diffusion.

LEDs of the latest generation generate comfortable light with significant energy savings. The quality of the materials goes hand in hand with technological solutions designed to increase the service life of the system.

The luminaire has an automatic temperature controller that reduces the luminous flux in the event of an abnormal temperature rise. Moreover, resistance to mains voltage peaks is ensured by a protection diode. Torcia is a street lamp that can strongly characterise a lighting installation, renovating the appearance of an area.



## 1513 - Torcia LED COB

Code: 423250-0016

### PHOTOMETRIC DATA



Lighting source	LED COB
CRI	≥80
Luminous flux (output) (lm)	4048 lm
Power absorption (total) (W)	53 W
CCT	4000 K
Low Flicker	luminaire with very low flicker: evenly distributed light for greater visual safety.
LED flux maintenance	50000 hr, L 80, B 20

### MECHANICAL CHARACTERISTICS

Impact resistance rating (IK)	IK08
IP	66
Ambient temperature - min	-20 °C
Ambient temperature - max	40 °C

# 1513 - Torcia LED COB

Code: 423250-0016

## MATERIALS AND COLOURS

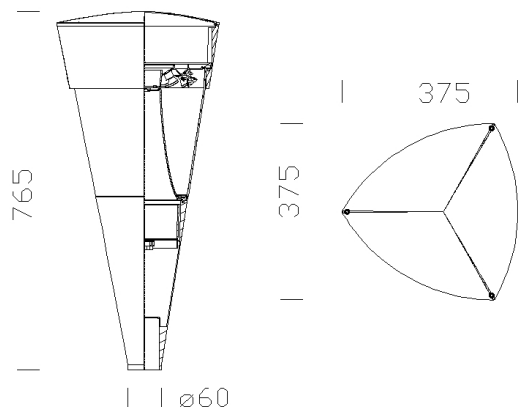

Housing	in die-cast aluminium.
Diffuser	in polycarbonate, transparent, anti-glare, shatterproof and V2 self-extinguishing, UV stabilised.
Heat sink	built-in.
Pole connection	suited for poles with a diameter of 60 mm.
Coating	pre-treatment of metal surface, polyester powder coating to ensure resistance to corrosion and salt spray fogs, UV stabilised.
Special coating (UPON REQUEST)	upon request: available with coating tested to withstand corrosion tests in aggressive artificial atmospheres (UNI EN ISO 9227) or marine environments (sea front).
Colour	Grey
Equipment	<ul style="list-style-type: none"> <li>- waterproof connector for quick installation with no need to open the fixture.</li> <li>- anti-condensation valve.</li> <li>- temperature controller with auto-reset.</li> <li>- EN 61547 compliant surge protection.</li> </ul>

## DOWNLOAD

### MOUNTS

[AssemblyInstructions torcia 03-23.pdf](#)

### DESIGNS

[BIM 1513 Torcia.zip](#)

[TechnicalDrawing 1513i.dxf](#)



## STANDARDS AND COMPLIANCE

Photobiological safety class	RG0 Ethr
Markings and tests	CE
Reference standards	EN60598-1. With degree of protection according to EN60529.
Energy Label	E

## WARRANTY

After sales warranty	5 yr
----------------------	------

# 1513 - Torcia LED COB

Code: 423250-0016

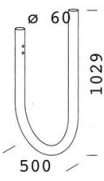

**129 Curved arm**

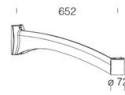

**301 Oliva arm**

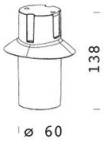

**303 Connection for  $\varnothing$  60**



**300 Oliva**



**211 Sector connector**

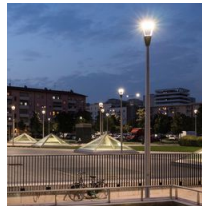

**1477 Urban Pole - with base**

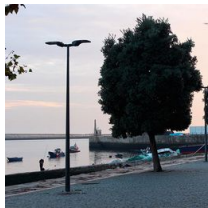

**1481 steel conical pole to be buried**

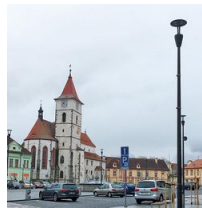

**1480 steel conical pole with base**



**1478 Urban Pole to be buried**

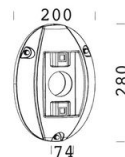

**302 Wall mount**



**1508 Fluted pole  $\varnothing$  120 with base**



**1509 Fluted pole  $\varnothing$  120**



**1408 Fluted pole  $\varnothing$  100 with base**



**1409 Fluted pole  $\varnothing$  100**