

1707 - Torcia LED

Code: 423252-39



Torcia with the new LED sources guarantees high lighting quality and with the unique reflector cone allows optimal light diffusion.

LEDs of the latest generation generate comfortable light with significant energy savings. The quality of the materials goes hand in hand with technological solutions designed to increase the service life of the system.

The luminaire has an automatic temperature controller that reduces the luminous flux in the event of an abnormal temperature rise. Moreover, resistance to mains voltage peaks is ensured by a protection diode. Torcia is a street lamp that can strongly characterise a lighting installation, renovating the appearance of an area.



GENERAL INFORMATION

Article	1707 - Torcia LED
Code	423252-39

DIMENSIONS AND WEIGHT

Length (mm)	375 mm
Width (mm)	375 mm
Height (mm)	765 mm
Weight (Kg)	7.7 kg

INSTALLATION

Diameter (Ø) of pole connector (mm)	60-60 mm
Surface exposed to wind (mm)	L 165000 mm ² , F 165000 mm ²

ELECTRICAL CHARACTERISTICS AND CONTROLS

Voltage type	AC
Min Voltage (V)	220 V
Max Voltage (V)	240 V
Min Frequency (Hz)	50 Hz
Max Frequency (Hz)	60 Hz
Frequency (Hz)	50 Hz
Wiring name	CLD
Power factor	≥0.9
Rated Current	240 mA
Surge protector (common) (EN 61547)	10 kV, 10 kV
Insulation class	Class II
Controllability	None

1707 - Torcia LED

Code: 423252-39

PHOTOMETRIC DATA

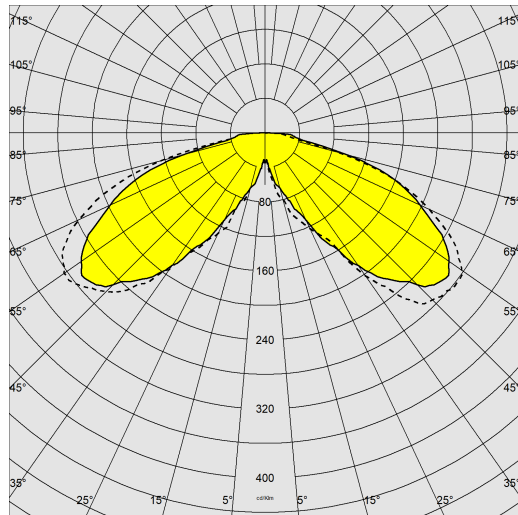

Lighting source	LED
CRI	>70
Luminous flux (output) (lm)	4278 lm
Power absorption (total) (W)	35 W
CCT	3000 K
Luminous efficacy (lm/W)	122 lm/W
Low Flicker	luminaire with very low flicker: evenly distributed light for greater visual safety.
LED flux maintenance	80000 hr, L 80, B 20

MECHANICAL CHARACTERISTICS

Impact resistance rating (IK)	IK08
IP	66
Ambient temperature - min	-20 °C
Ambient temperature - max	40 °C

1707 - Torcia LED

Code: 423252-39

MATERIALS AND COLOURS

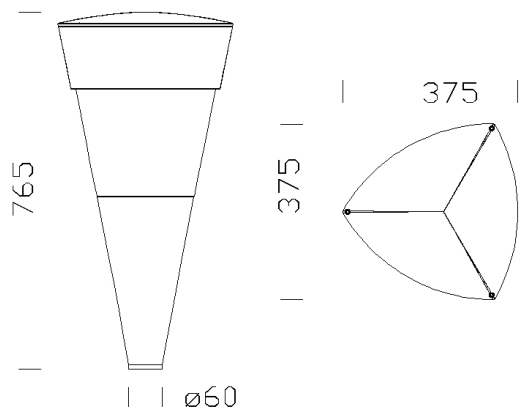

Housing	in die-cast aluminium.
Diffuser	in polycarbonate, transparent, anti-glare, shatterproof and V2 self-extinguishing, UV stabilised.
Heat sink	built-in.
Pole connection	suited for poles with a diameter of 60 mm.
Coating	pre-treatment of metal surface, polyester powder coating to ensure resistance to corrosion and salt spray fogs, UV stabilised.
Special coating (UPON REQUEST)	upon request: available with coating tested to withstand corrosion tests in aggressive artificial atmospheres (UNI EN ISO 9227) or marine environments (sea front).
Colour	Grey
Equipment	<ul style="list-style-type: none"> - waterproof connector for quick installation with no need to open the fixture. - anti-condensation valve. - temperature controller with auto-reset. - EN 61547 compliant surge protection. - ADVANCED PROG built-in functions.

DOWNLOAD

MOUNTS

[AssemblyInstructions torcia 03-23.pdf](#)

DESIGNS

[BIM 1707 Torcia.zip](#)

[TechnicalDrawing 1707.dxf](#)



STANDARDS AND COMPLIANCE

Photobiological safety class	RG0 Ethr
Markings and tests	CE
Reference standards	EN60598-1. With degree of protection according to EN60529.
Energy Label	B

WARRANTY

After sales warranty	5 yr
----------------------	------

1707 - Torcia LED

Code: 423252-39

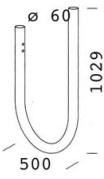

129 Curved arm

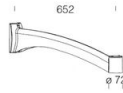

301 Oliva arm

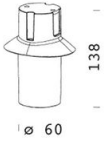

303 Connection for \varnothing 60



300 Vert olive



211 Sector connector

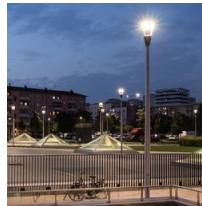

1477 Urban Pole - with base

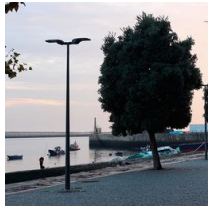

1481 steel conical pole to be buried

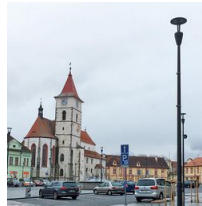

1480 steel conical pole with base



1478 Urban Pole to be buried

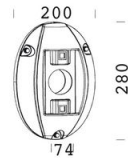

302 Wall mount



1508 Fluted pole \varnothing 120 with base



1509 Fluted pole \varnothing 120



1408 Fluted pole \varnothing 100 with base



1409 Fluted pole \varnothing 100