

1537 - Koala - COB

Code: 431829-00

GENERAL INFORMATION

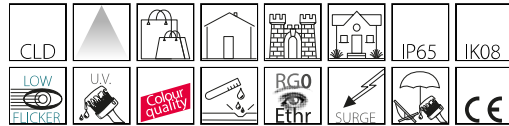

Article	1537 - Koala - COB
Code	431829-00

DIMENSIONS AND WEIGHT

Height (mm)	196 mm
Diameter (Ø) (mm)	127 mm
Weight (Kg)	0.8 kg

ELECTRICAL CHARACTERISTICS AND CONTROLS

Voltage type	AC
Min Voltage (V)	220 V
Max Voltage (V)	240 V
Min Frequency (Hz)	50 Hz
Max Frequency (Hz)	60 Hz
Frequency (Hz)	50 Hz
Wiring name	CLD
Power factor	≥0.9
Insulation class	Class I
Controllability	None



Restyling of the classic garden spotlight with a slender shape. The LED in outdoor lighting is now a guarantee for quality with the advantage of significant energy savings. In the LED version, Koala ensures excellent colour rendering that guarantee perfect, homogeneous light, especially for the lighting of monuments or building façades. Carefully designed for maximum efficiency and durability. Available with multiple accessories and in three colours: silver, graphite, corten.



1537 - Koala - COB

Code: 431829-00

PHOTOMETRIC DATA

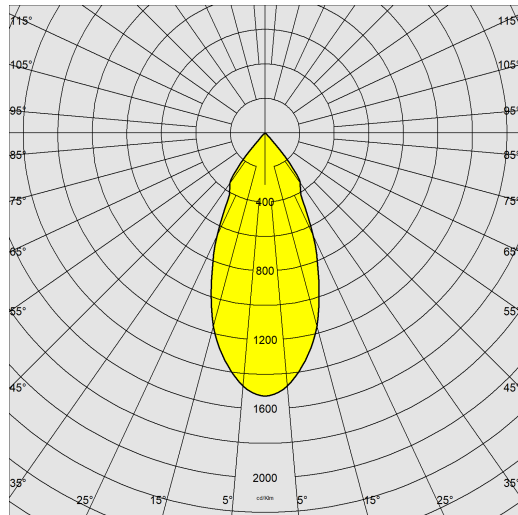

Lighting source	LED COB
CRI	80
Luminous flux (output) (lm)	1195 lm
Power absorption (total) (W)	15 W
CCT	3000 K
Luminous efficacy (lm/W)	80 lm/W
Beam angle	46 °
LED flux maintenance	50000 hr, L 70, B 50

MECHANICAL CHARACTERISTICS

Impact resistance rating (IK)	IK08
IP	65



1537 - Koala - COB

Code: 431829-00

MATERIALS AND COLOURS

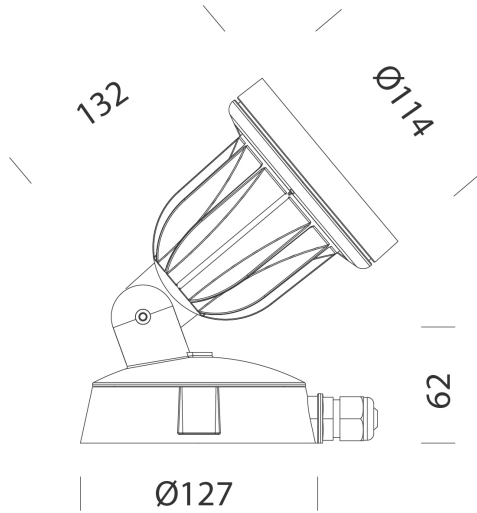

Housing	in die-cast aluminium with cooling fins integrated in the cover.
Optics	in high-performance metallised polycarbonate.
Diffuser	screen-printed, tempered glass.
Coating	pre-treatment of metal surface, polyester powder coating, resistance to corrosion, UV stabilised. Standard with coating for marine environments in compliance with UNI EN ISO 9227.
Special coating (UPON REQUEST)	Upon request: protective coating recommended for marine environments within 5 km (3 miles) of the sea.
Colour	Graphite
Equipment	cable gland diam. 3/8.

STANDARDS AND COMPLIANCE

Photobiological safety class	RG0 Ethr
Markings and tests	CE
Reference standards	EN60598-1. With degree of protection according to EN60529.
Energy Label	E

DOWNLOAD

MOUNTS

[AssemblyInstructions KOALA 09-22.pdf](#)

DESIGNS

[BIM 1537 Koala - COB](#)

[TechnicalDrawing 1537di.dxf](#)

WARRANTY

After sales warranty	3 yr
----------------------	------



1537 - Koala - COB

Code: 431829-00



118 Terminal

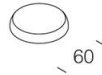

115 Pole cap

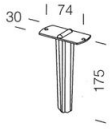

119 Spike



116 Angle support

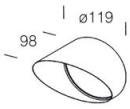

114 Conveyor

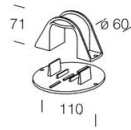

120 Pole support