

2577 - Square - with reflector

Code: 431862-00

GENERAL INFORMATION

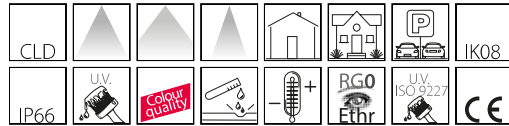

Article	2577 - Square - with reflector
Code	431862-00

DIMENSIONS AND WEIGHT

Length (mm)	120 mm
Width (mm)	120 mm
Height (mm)	160 mm
Weight (Kg)	2.6 kg

ELECTRICAL CHARACTERISTICS AND CONTROLS

Voltage type	AC
Min Voltage (V)	220 V
Max Voltage (V)	240 V
Min Frequency (Hz)	50 Hz
Max Frequency (Hz)	60 Hz
Frequency (Hz)	50 Hz
Wiring name	CLD
Power factor	≥0.92
Insulation class	Class I
Controllability	None



Today, lighting is asked to do more than ever. To effectively illuminate a room, in addition to providing the necessary amount of light, proper attention must also be paid to aesthetics, luminaire design and light distribution. Without forgetting sustainable energy consumption. Square is the new LED luminaire designed to always provide the best lighting quality, with maximum reliability in every context, whether outdoor or indoor.

In the wall-mounted version, with direct and indirect light, Square ensures maximum functionality and aesthetics with very low consumption, in different versions to achieve the best light distribution. The sturdiness of the materials, with a die-cast aluminum housing and tempered glass diffuser resistant to thermal shock and impact, also makes this product ideal for outdoor use.

It's easy installation, without the need to open the fixture, makes Square LED particularly suited to illuminate a facade with class and elegance.

The Square range also includes a spotlight version, with lens or fully adjustable square optics to achieve the desired lighting scenario.

Luminaires are equipped with LEDs that ensure a very long lifespan, low consumption and high light quality.



2577 - Square - with reflector

Code: 431862-00

PHOTOMETRIC DATA



Lighting source	LED COB
CRI	80
Luminous flux (output) (lm)	4390 lm
Power absorption (total) (W)	40 W
CCT	4000 K
Luminous efficacy (lm/W)	110 lm/W
Beam angle	28 °
LED flux maintenance	50000 hr, L 80, B 20

MECHANICAL CHARACTERISTICS

Impact resistance rating (IK)	IK08
IP	66



2577 - Square - with reflector

Code: 431862-00

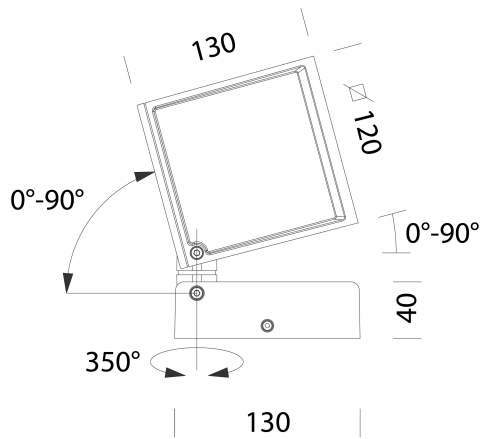

DOWNLOAD

MOUNTS

[AssemblyInstructions Square 09-22.pdf](#)

DESIGNS

[TechnicalDrawing squabas.dxf](#)

[TechnicalDrawing3D disano 2577 square.3ds](#)



MATERIALS AND COLOURS

Housing	in die-cast aluminium.
Optics	in high-performance silver-coated aluminium.
Diffuser	extra-clear, tempered glass, 4 mm thick, resistant to thermal shock and impact (UNI-EN 12150-1:2001).
Coating	pre-treatment of metal surface, polyester powder coating to ensure resistance to corrosion and salt spray fogs, UV stabilised.
Special coating (UPON REQUEST)	upon request: available with coating tested to withstand corrosion tests in aggressive artificial atmospheres (UNI EN ISO 9227) or marine environments (sea front).
Colour	White
Equipment	- with wall mounting plate. - complete with waterproof connector for line connection.

STANDARDS AND COMPLIANCE

Photobiological safety class	RG0 Ethr
Markings and tests	CE
Reference standards	EN60598-1. With degree of protection according to EN60529.
Energy Label	D

GEAR

Upon request	1/10 DIMM or DALI versions, 3000K versions with subcode -39.
--------------	--

WARRANTY

After sales warranty	3 yr
----------------------	------