

1515 - Elfo - DIP SWITCH - FL

Code: 432836-00

GENERAL INFORMATION

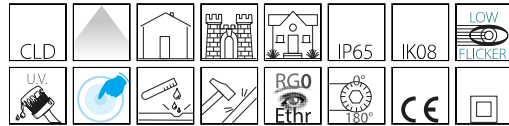

Article	1515 - Elfo - DIP SWITCH - FL
Code	432836-00

DIMENSIONS AND WEIGHT

Length (mm)	220 mm
Width (mm)	220 mm
Height (mm)	310 mm
Weight (Kg)	2.6 kg

ELECTRICAL CHARACTERISTICS AND CONTROLS

Voltage type	AC
Min Voltage (V)	220 V
Max Voltage (V)	240 V
Min Frequency (Hz)	50 Hz
Max Frequency (Hz)	60 Hz
Frequency (Hz)	50 Hz
Wiring name	CLD
Power factor	≥0.9
Rated Current	900 mA
Insulation class	Class II
Controllability	None



A complete product that meets needs and wishes of lighting designers.



1515 - Elfo - DIP SWITCH - FL

Code: 432836-00

PHOTOMETRIC DATA

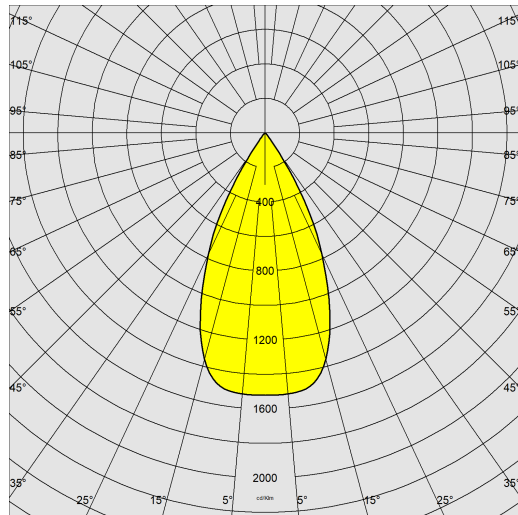

Lighting source	LED COB
CRI	80
Luminous flux (output) (lm)	5700 lm
Power absorption (total) (W)	49 W
CCT	4000 K
Luminous efficacy (lm/W)	116 lm/W
Beam angle	50 °
LED flux maintenance	50000 hr, L 90, B 10

MECHANICAL CHARACTERISTICS

Impact resistance rating (IK)	IK08
IP	65



1515 - Elfo - DIP SWITCH - FL

Code: 432836-00

MATERIALS AND COLOURS

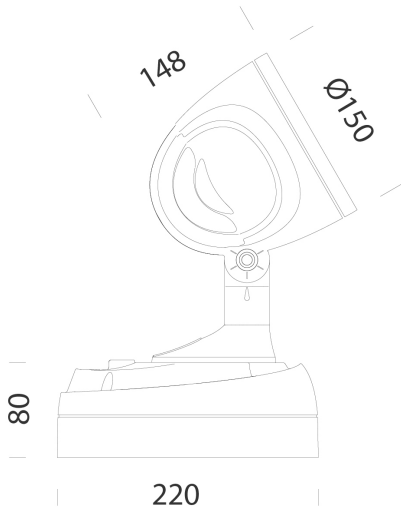

DOWNLOAD

MOUNTS

[AssemblyInstructions elfo 02-25.pdf](#)

DESIGNS

[BIM 1515 02-26.zip](#)

[TechnicalDrawing elfoled.dxf](#)

[TechnicalDrawing3D disano 1515 elfo.3ds](#)



Housing	in die-cast aluminium with cooling fins integrated in the cover.
Optics	in high-performance silver-coated aluminium.
Diffuser	tempered glass, 4 mm thick, resistant to thermal shock and impact (UNI EN 12150-1:2001).
Coating	the fully automated powder-coating cycle involves a polyester-based, salt-spray corrosion-resistant and UV-stabilised paint.
Special coating (UPON REQUEST)	Upon request: protective coating recommended for marine environments within 5 km (3 miles) of the sea.
Colour	Grey
Equipment	silicone and EPDM rubber sealing gasket. Rubber cable gland Ø 1/2 gas inch.
	Luminous flux maintenance 70%: 100.000h (L70B50) o luminous flux maintenance 90%: 50.000h (L90B10).

STANDARDS AND COMPLIANCE

Photobiological safety class	RG0 Ethr
Markings and tests	CE
Reference standards	EN60598-1. They have a degree of protection according to the EN60529 standard.
Energy Label	D

WARRANTY

After sales warranty	3 yr
----------------------	------

1515 - Elfo - DIP SWITCH - FL

Code	LED	WTot	K - Lumen Output - CRI - Degrees
432836-00	900	49	4000K - 5700lm – CRI80 – 50°
432836-00	700	37	4000K - 4515lm – CRI80 – 50°
432836-00	500	26	4000K - 3280lm – CRI80 – 50°
432837-00	900	49	4000K - 5700lm – CRI80 – 50°
432837-00	700	37	4000K - 4515lm – CRI80 – 50°
432837-00	500	26	4000K - 3280lm – CRI80 – 50°

1515 - Elfo - DIP SWITCH - FL

Code: 432836-00

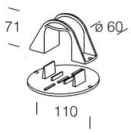

120 Pole support

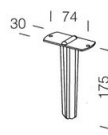

119 Spike

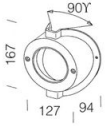

116 Angle support

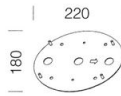

188 Board