

1515 - Elfo Amber - FL

Code: 432836-73

GENERAL INFORMATION

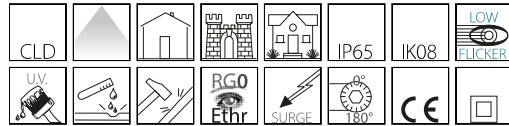

Article	1515 - Elfo Amber - FL
Code	432836-73

DIMENSIONS AND WEIGHT

Length (mm)	200 mm
Width (mm)	150 mm
Height (mm)	300 mm
Diameter (Ø) (mm)	150 mm
Weight (Kg)	2.60 kg

ELECTRICAL CHARACTERISTICS AND CONTROLS

Voltage type	AC
Min Voltage (V)	220 V
Max Voltage (V)	240 V
Min Frequency (Hz)	50 Hz
Max Frequency (Hz)	60 Hz
Frequency (Hz)	50 Hz
Wiring name	CLD
Power factor	≥0.9
Insulation class	Class II
Controllability	None



Un prodotto completo per realizzare al meglio tutti i desideri del progettista di luce.



1515 - Elfo Amber - FL

Code: 432836-73

PHOTOMETRIC DATA

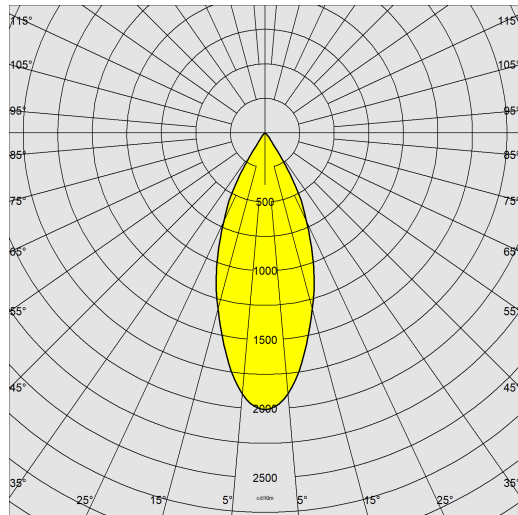

Lighting source	LED AMBER
CRI	amber
Luminous flux (output) (lm)	5200 lm
Power absorption (total) (W)	57 W
CCT	2200 K
Luminous efficacy (lm/W)	91 lm/W
Beam angle	50 °
LED flux maintenance	50000 hr, L 80, B 20

MECHANICAL CHARACTERISTICS

Impact resistance rating (IK)	IK08
IP	65



1515 - Elfo Amber - FL

Code: 432836-73

MATERIALS AND COLOURS

Housing	in die-cast aluminium with cooling fins integrated in the cover.
Optics	0
Diffuser	0
Coating	pre-treatment of metal surface, polyester powder coating to ensure resistance to corrosion and salt spray fogs, UV stabilised.
Colour	Grey
Equipment	0

STANDARDS AND COMPLIANCE

Photobiological safety class	RG0 Ethr
Markings and tests	CE
Reference standards	EN60598-1. With degree of protection according to EN60529.
Energy Label	D

WARRANTY

After sales warranty	3 yr
----------------------	------

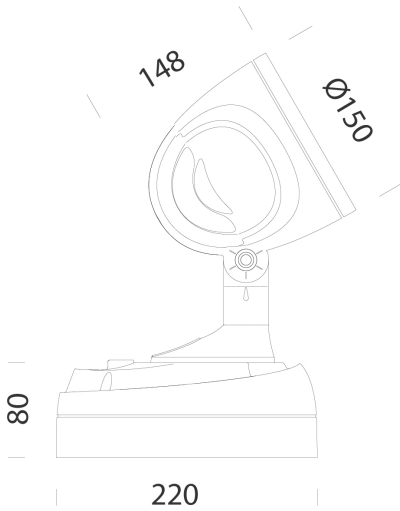

DOWNLOAD

MOUNTS

[AssemblyInstructions Elfo 03-23.pdf](#)

DESIGNS

[TechnicalDrawing elfoled.dxf](#)



1515 - Elfo Amber - FL

Code: 432836-73

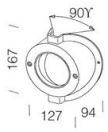

116 Angle support

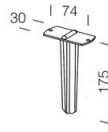

119 Spike

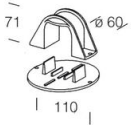

120 Pole support

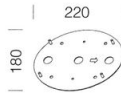

188 Board