

1515 - Elfo - DIP SWITCH - FL

Code: 432837-00

GENERAL INFORMATION

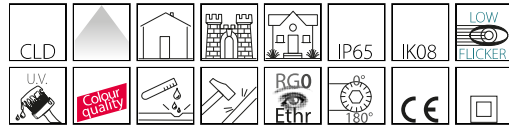

Article	1515 - Elfo - DIP SWITCH - FL
Code	432837-00

DIMENSIONS AND WEIGHT

Length (mm)	200 mm
Width (mm)	150 mm
Height (mm)	300 mm
Diameter (Ø) (mm)	150 mm
Weight (Kg)	2.575 kg

ELECTRICAL CHARACTERISTICS AND CONTROLS

Voltage type	AC
Min Voltage (V)	220 V
Max Voltage (V)	240 V
Min Frequency (Hz)	50 Hz
Max Frequency (Hz)	60 Hz
Frequency (Hz)	50 Hz
Wiring name	CLD
Power factor	≥0.9
Rated Current	900 mA
Insulation class	Class II
Controllability	None



A complete product that meets needs and wishes of lighting designers.



1515 - Elfo - DIP SWITCH - FL

Code: 432837-00

PHOTOMETRIC DATA

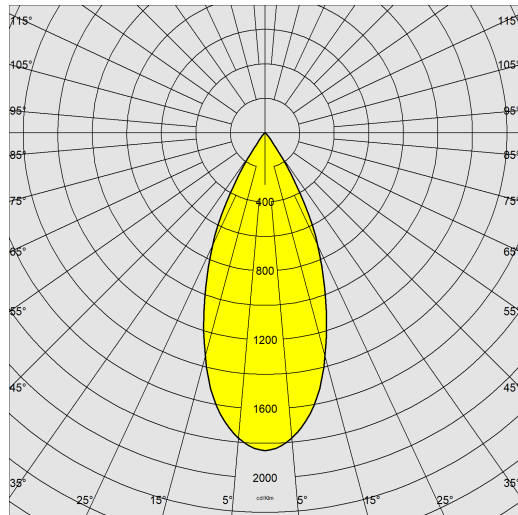

Lighting source	LED COB
CRI	80
Luminous flux (output) (lm)	5700 lm
Power absorption (total) (W)	49 W
CCT	4000 K
Luminous efficacy (lm/W)	116 lm/W
Beam angle	40 °
LED flux maintenance	50000 hr, L 80, B 20

MECHANICAL CHARACTERISTICS

Impact resistance rating (IK)	IK08
IP	65



1515 - Elfo - DIP SWITCH - FL

Code: 432837-00

MATERIALS AND COLOURS

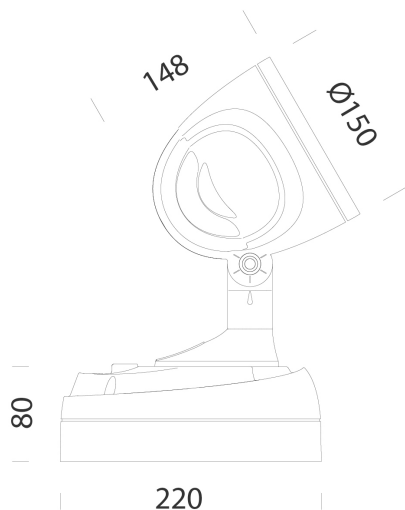

DOWNLOAD

MOUNTS

[AssemblyInstructions Elfo 03-23.pdf](#)

DESIGNS

[TechnicalDrawing elfoled.dxf](#)

[TechnicalDrawing3D disano 1515 elfo.3ds](#)



Housing	in die-cast aluminium with cooling fins integrated in the cover.
Optics	in high-performance silver-coated aluminium.
Diffuser	tempered glass, 4 mm thick, resistant to thermal shock and impact (UNI EN 12150-1:2001).
Coating	pre-treatment of metal surface, polyester powder coating to ensure resistance to corrosion and salt spray fogs, UV stabilised.
Colour	Graphite
Equipment	silicone and EPDM rubber sealing gasket. Rubber cable gland Ø 1/2 gas inch.

STANDARDS AND COMPLIANCE

Photobiological safety class	RG0 Ethr
Markings and tests	CE
Reference standards	EN60598-1. With degree of protection according to EN60529.
Energy Label	D

WARRANTY

After sales warranty	3 yr
----------------------	------

1515 - Elfo - DIP SWITCH - FL

Code	Wiring	The LEDs	WTot	K - Lumen Output - CRI - Degrees
432836-00	CLD	900	49	4000K - 5700lm – CRI80 – 40°
432836-00	CLD	700	37	4000K - 4515lm – CRI80 – 40°
432836-00	CLD	500	26	4000K - 3280lm – CRI80 – 40°
432837-00	CLD	900	49	4000K - 5700lm – CRI80 – 40°
432837-00	CLD	700	37	4000K - 4515lm – CRI80 – 40°
432837-00	CLD	500	26	4000K - 3280lm – CRI80 – 40°

1515 - Elfo - DIP SWITCH - FL

Code: 432837-00

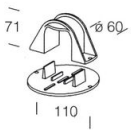

120 Pole support

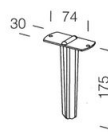

119 Spike

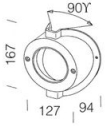

116 Angle support

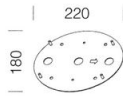

188 Board