

508 - Double arm

Code: 991267-00

GENERAL INFORMATION

Article	508 - Double arm
Code	991267-00

DIMENSIONS AND WEIGHT

Length (mm)	1040 mm
Width (mm)	100 mm
Height (mm)	350 mm
Weight (Kg)	9 kg

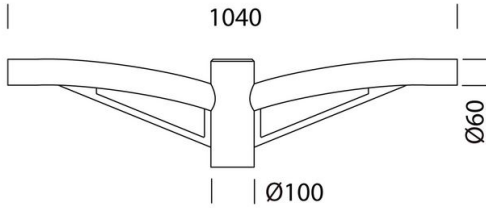

in steel, suitable for installation on poles with Ø60 connection.



508 - Double arm

Code: 991267-00



508 - Double arm

Code: 991267-00

MATERIALS AND COLOURS

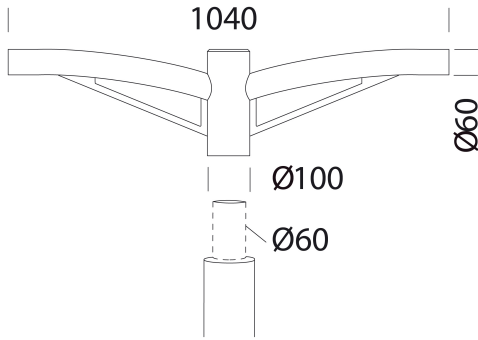

Housing	in steel, suitable for installation on poles with Ø60 connection.
Pole connection	60mm
Colour	Graphite

WARRANTY

After sales warranty	0 yr
----------------------	------

DOWNLOAD

DESIGNS

TechnicalDrawing 508.dxf



508 - Double arm

Code: 991267-00



3472 Giovi M1 - street



3269 Mini Stelvio FX T5 - wide beam



3278 Mini Stelvio FX T3 - wide beam street



3376 Mini Stelvio - high performance - large areas



3285 Rolle - high performance



3286 Rolle - high performance



3476 Mini Giovi W2 - street

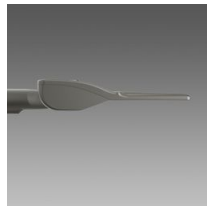

3477 Mini Giovi N1 - cycle lane



3478 Mini Giovi M1 - street



3479 Mini Giovi T4 - large areas



3480 Mini Giovi - high performance - large areas

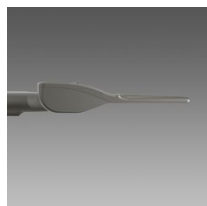

3481 Mini Giovi - high performance - street ME

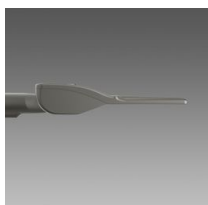

3482 Mini Giovi - high performance - cycle lane

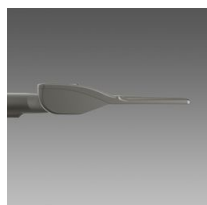

3483 Mini Giovi AMBRA - large areas

508 - Double arm

Code: 991267-00

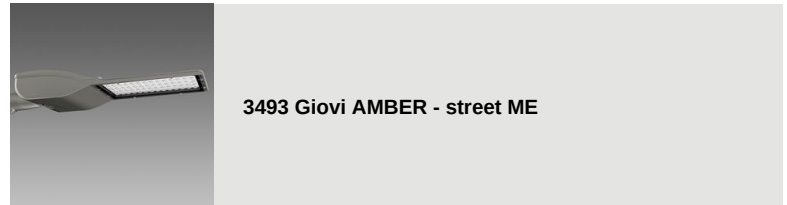
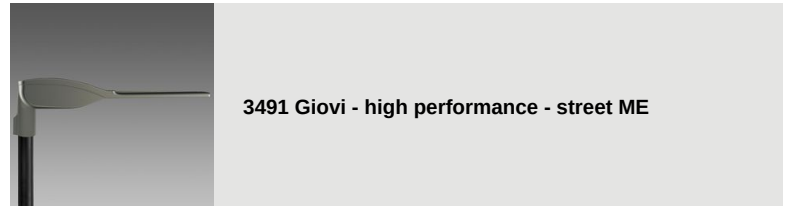
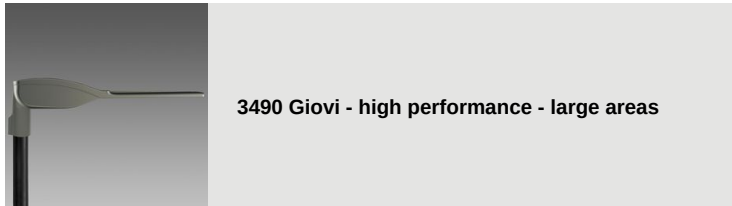



3375 Mini Stelvio - high performance - street



3280 Rolle - T1



3283 Rolle - T4



3284 Rolle - T5



3290 Sella 1 - ST



3291 Sella 1 - STWB



3292 Sella 1 - asymmetric 45°



3293 Sella 1 - asymmetric 60°

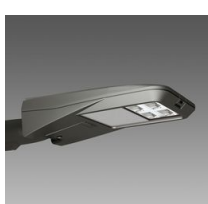

3294 Sella 1 - cycle lanes



3295 Sella 1 - large areas



3296 Sella 1 - HP



3297 Sella 1 - HP -pedestrian crossings LH



3298 Sella 1 - HP -pedestrian crossings RH



3390 Sella 2 - ST



3391 Sella 2 - STWB



3392 Sella 2 - asymmetric 45°



3393 Sella 2 - asymmetric 60°



3395 Sella 2 - large areas



3396 Sella 2 - HP



3270 Stelvio 1 - Plus - LED



3274 Stelvio 2 - Plus - LED asymmetric



3370 Stelvio - high performance - street



3374 Stelvio - high performance - large areas



3475 Mini Giovi W1 - street



3275 Mini Stelvio - street



3276 Mini Stelvio - asymmetric



3281 Rolle - T2



3282 Rolle - T3



Please contact the Consulting and Design Centre for any technical information. The reported luminous flux is the flux emitted by the light source with a tolerance of $\pm 10\%$ compared to the indicated value. The total wattage absorbed by the system will not exceed 10% of the reported value. Technical lighting data may be subject to changes and improvements due to the fast evolution of the technology. Wednesday, December 25, 2024