

371 - Plug for quick connection

Code: 998041-00

GENERAL INFORMATION

Article	371 - Plug for quick connection
Code	998041-00

DIMENSIONS AND WEIGHT

Height (mm)	62 mm
Diameter (Ø) (mm)	30 mm
Weight (Kg)	0.050 kg



in polycarbonate. To be used for continuous line with cable.
Cable gland with incoming cable of 16A min. Ø 9 max Ø12 mm.
Package containing 10 pieces.
998045-00: 5P



371 - Plug for quick connection

Code: 998041-00



371 - Plug for quick connection

Code: 998041-00

WARRANTY

After sales warranty

0 yr

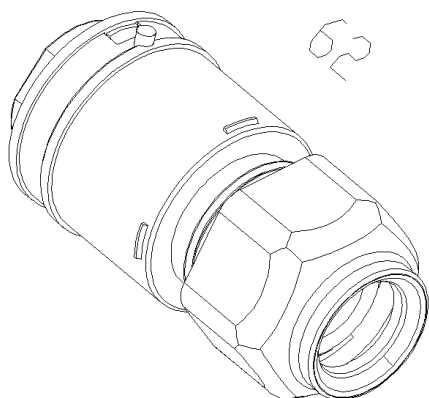

DOWNLOAD

DESIGNS

TechnicalDrawing 371.dxf



371 - Plug for quick connection

Code: 998041-00

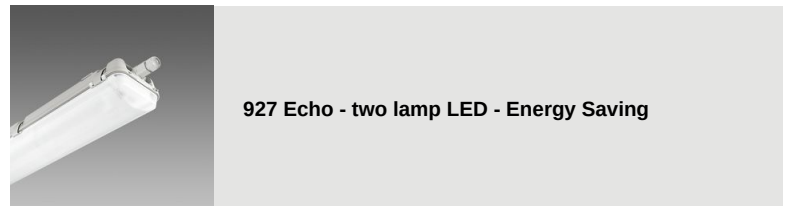
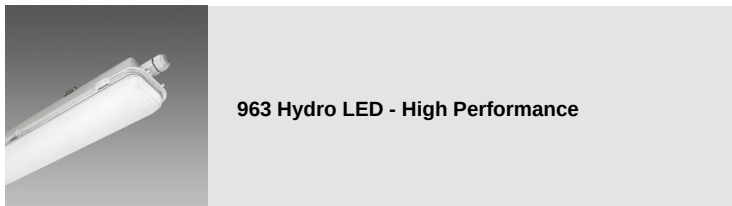
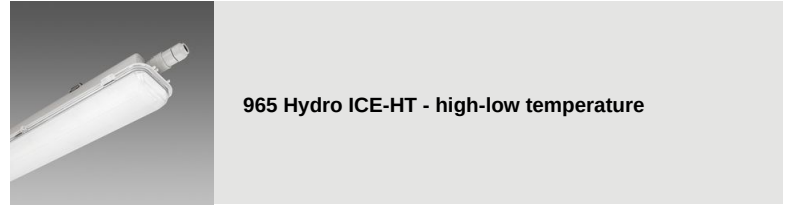
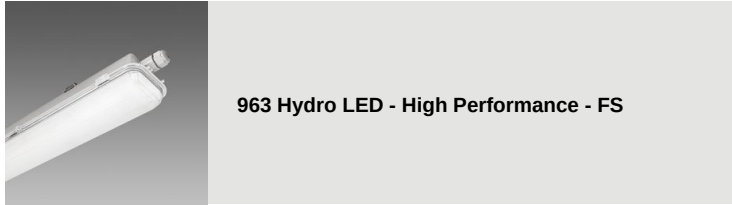
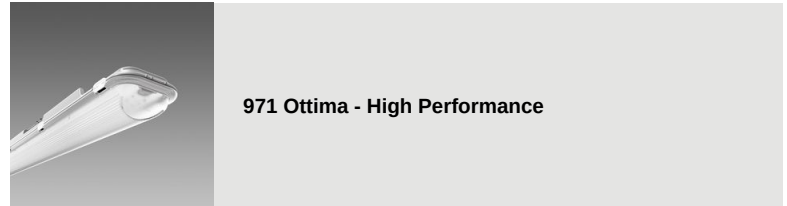
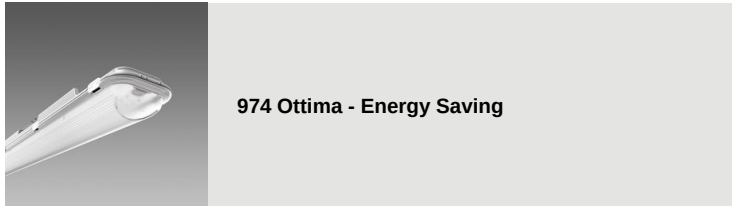

371 - Plug for quick connection

Code: 998041-00



957 Echo FS - two lamp LED - High Performance



958 Echo PARKING - double LED module