

960 - Hydro LED - Money Saving

Code: 164752-19

GENERAL INFORMATION

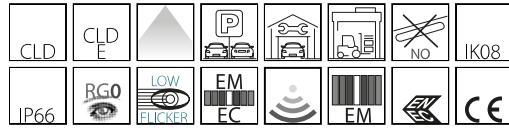

Article	960 - Hydro LED - Money Saving
Code	164752-19

DIMENSIONS AND WEIGHT

Length (mm)	1260 mm
Width (mm)	120 mm
Height (mm)	102 mm
Weight (Kg)	1.9 kg

ELECTRICAL CHARACTERISTICS AND CONTROLS

Voltage type	AC
Min Voltage (V)	220 V
Max Voltage (V)	240 V
Min Frequency (Hz)	50 Hz
Max Frequency (Hz)	60 Hz
Frequency (Hz)	50 Hz
Wiring name	CLD
Power factor	≥0.95
Insulation class	Class I
Controllability	None



Disano Group's vast technological experience in the design and industrial production of lighting fixtures has led to the development of its new range of watertight LED fixtures. New Hydro LED is characterised by a modern design that blends well into any setting.



960 - Hydro LED - Money Saving

Code: 164752-19

PHOTOMETRIC DATA



Lighting source	LED
CRI	≥80
Luminous flux (output) (lm)	3219 lm
Power absorption (total) (W)	27 W
CCT	4000 K
Low Flicker	luminaire with very low flicker: evenly distributed light for greater visual safety.
LED flux maintenance	80000 hr, L 80, B 20

MECHANICAL CHARACTERISTICS

Impact resistance rating (IK)	IK08
IP	66
Ambient temperature - min	-30 °C
Ambient temperature - max	40 °C

960 - Hydro LED - Money Saving

Code: 164752-19

MATERIALS AND COLOURS

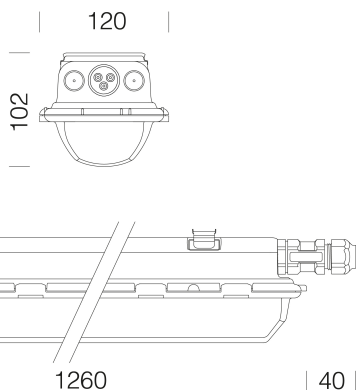

DOWNLOAD

MOUNTS

[AssemblyInstructions hydro - thema 12-23.pdf](#)

DESIGNS

[BIM 960 Hydro LED - Money Saving.zip](#)

[TechnicalDrawing 960k.dxf](#)



Housing	injection-moulded, made of grey RAL 7035 polycarbonate, shatterproof, UV-stabilised, with high mechanical strength thanks to the structure reinforced by internal ribs.
Optics	galvanised steel pre-painted in oven with white polyester resin, UV-stabilised. Fastened to the body with a quick coupling by means of a device machined directly on the body.
Diffuser	injection-moulded in polycarbonate with internal grooves for greater light control, self-extinguishing V2, UV-stabilised, smooth outer finish to enable easy cleaning for maximum light efficiency.
Colour	Grey
Equipment	<ul style="list-style-type: none"> - sealing gasket in eco-friendly, anti-aging expanded polyurethane foam - ceiling mounting brackets and suspension hook in stainless steel - quick connector - clamp and safety screws in stainless steel
<p>ATTENTION ! Do not install on surfaces subject to strong vibrations, outdoors on hanging cables, or on walls under metallic grates, or on poles, and in any case, never expose the fixture to direct sunlight. Check the compatibility between the material constituting the product and the space where it will be installed. We recommend the use of fixtures made of steel with direct exposure to sunlight.</p>	

STANDARDS AND COMPLIANCE

Photobiological safety class	RG0
Markings and tests	CE, ENEC
Reference standards	EN60598-1. With degree of protection according to EN60529. The lighting fixture meets all IFS and BRC requirements, and the regulation of the HACCP Directive regarding lighting systems installed in food processing plants.
Laboratory Tests	<ul style="list-style-type: none"> - the UL 94 Standard is considered a reference for rating the ignition characteristics of plastic materials. The watertight fixtures are made of V2 class material that self-extinguishes in 25 seconds. - passes the Glow Wire Test at 850 °C.
Energy Label	C

GEAR

Upon request	<ul style="list-style-type: none"> - narrow beam, subcode -22 - continuous row with connector on both ends, subcode -0072 - radar sensor for ON-OFF watertight fixtures, subcode -19 - with CLD-EC wiring for centrally powered emergency lighting, subcode -0050
--------------	---

WARRANTY

After sales warranty	3 yr
----------------------	------

960 - Hydro LED - Money Saving

Code: 164752-19



975 Anti-impact grid