

## 975 - Gabbia antiurti

Codice: 165566-00

### INFORMAZIONI GENERALI

Articolo	975 - Gabbia antiurti
Codice	165566-00

### DIMENSIONI E PESO

Lunghezza (mm)	1300 mm
Larghezza (mm)	275 mm
Peso (Kg)	1.2 kg

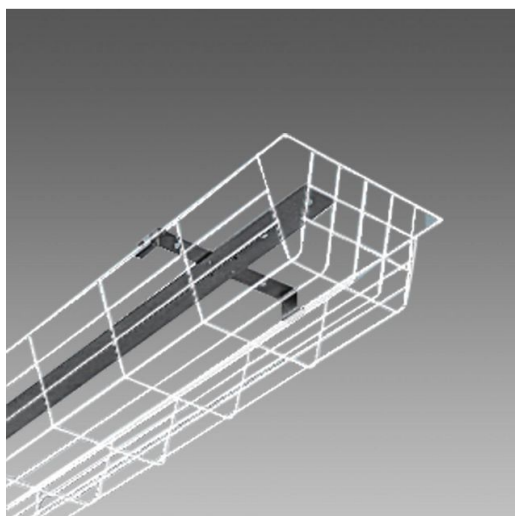

975 Gabbia antiurti



## 975 - Gabbia antiurti

Codice: 165566-00

DATI FOTOMETRICI

Sorgente luminosa

FL 2x36



## 975 - Gabbia antiurti

Codice: 165566-00

### MATERIALI E COLORI

Corpo	in tondino di acciaio plastificato bianco. Gabbia antiurti da fissare direttamente a plafone.
Verniciatura	verniciato per cataforesi epossidica.
Colore	Bianco

### GARANZIA

Garanzia post-vendita	0 yr
-----------------------	------

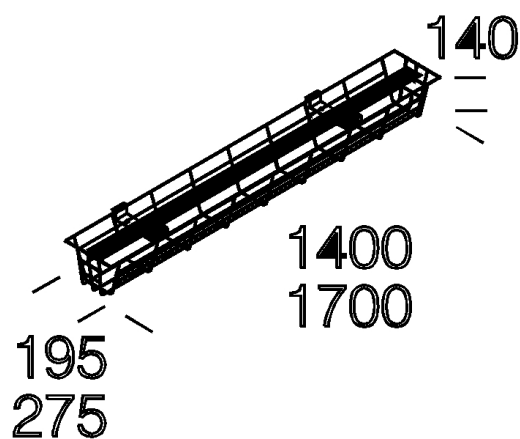

### DOWNLOAD

DISEGNI

DisegnoTecnico d975.dxf



## 975 - Gabbia antiurti

Codice: 165566-00



**983 Forma LED - senza ganci per industria alimentare**



**988 Forma LED HT - High temperature**



**993 Forma LED - vetro trasparente**



**995 Forma LED - con vetro acidato**



**997 Forma LED - con diffusore in policarbonato**



**971 Ottima - High Performance**



**974 Ottima - Energy Saving**



**970 Thema - LED**



**960 Hydro LED - Money Saving**



**963 Hydro LED - High Performance**



**965 Hydro ICE-HT - high-low temperature**



**963 Hydro LED - High Performance - FS**