

## Sospensione semplice acciaio

Codice: 22003166-00

### INFORMAZIONI GENERALI

Articolo	Sospensione semplice acciaio
Codice	22003166-00

### DIMENSIONI E PESO

Peso (Kg)	0.09 kg
-----------	---------



sospensione completa di cavetto in acciaio diam 1.5 mm e lunghezza 1,75 m con regolazione millimetrica. Carico max.: 20 Kg.



## Sospensione semplice acciaio

---

Codice: 22003166-00



## Sospensione semplice acciaio

Codice: 22003166-00

### MATERIALI E COLORI

Corpo	sospensione completa di cavetto in acciaio diam 1.5 mm e lunghezza 1,75 m con regolazione millimetrica. Carico max.: 20 Kg.
Colore	Nichel

### NORME E CONFORMITÀ

Marcature e test	CE
------------------	----

### GARANZIA

Garanzia post-vendita	0 yr
-----------------------	------

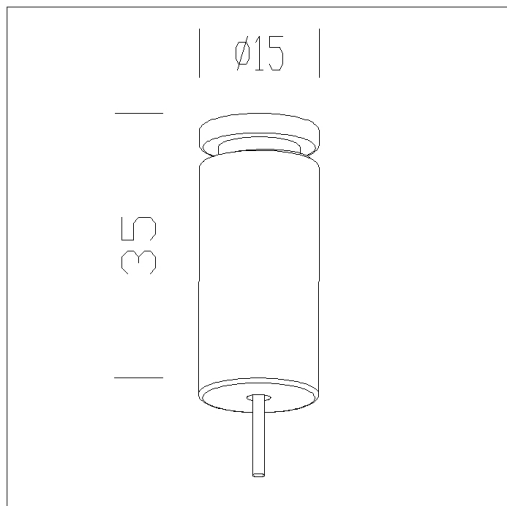

### DOWNLOAD

#### MONTAGGI

IstruzioniMontaggio 3166-rev-1.pdf

#### DISEGNI

DisegnoTecnico sospsing.dxf



## Sospensione semplice acciaio

Codice: 22003166-00



Eco Pannello luminoso R4



Liset 2.0 - a sospensione - diretta - Dark light - UGR<19



Liset 2.0 - a sospensione - diretta indiretta - Dark light - UGR<19



Liset 2.0 - a sospensione - diretta - ottiche comfort - UGR<19

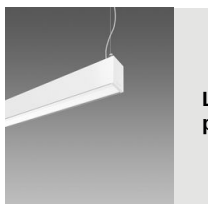

Liset 2.0 - a sospensione - luce diretta - diffusore in policarbonato



Liset 2.0 - C 4M

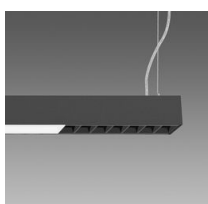

Liset 2.0 - C+2M

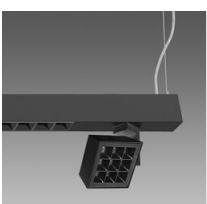

Liset 2.0 - C+M+2S - UGR<19

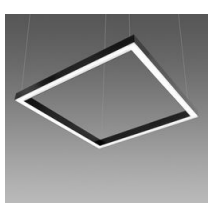

Liset 2.0 - C 4D



Liset 2.0 - C 2D+2M



Liset 2.0 - C+2S



Liset 2.0 - C+H+3M - UGR<19



Liset 2.0 HE - sospensione luce diretta - 90°



Liset 2.0 HE - sospensione luce diretta - 30°x80°

## Sospensione semplice acciaio

Codice: 22003166-00

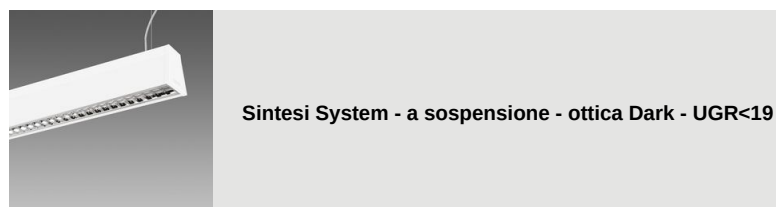
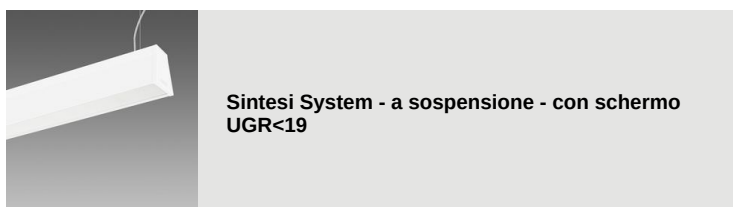
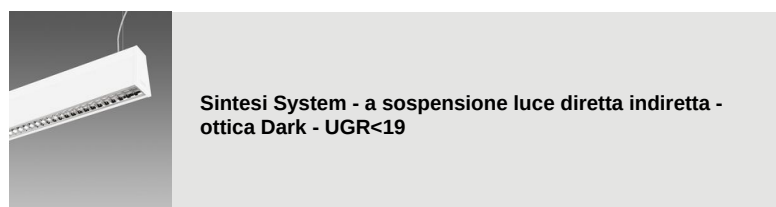
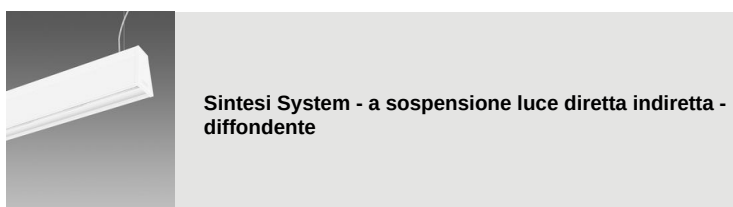
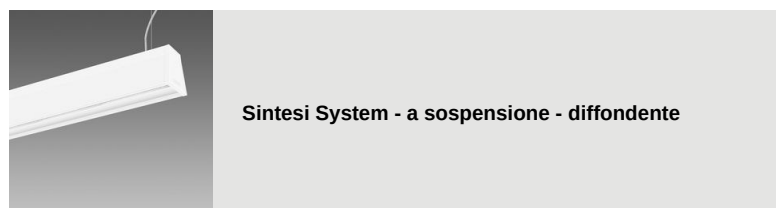
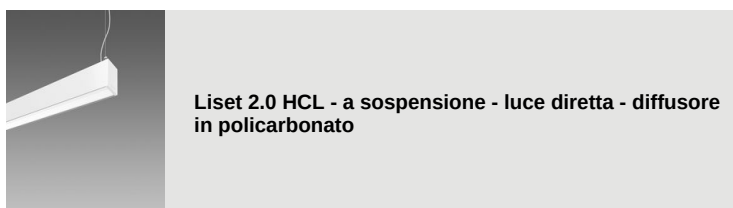
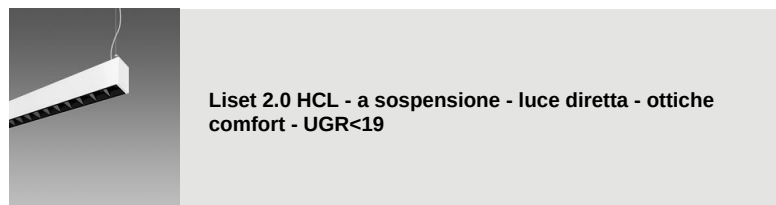
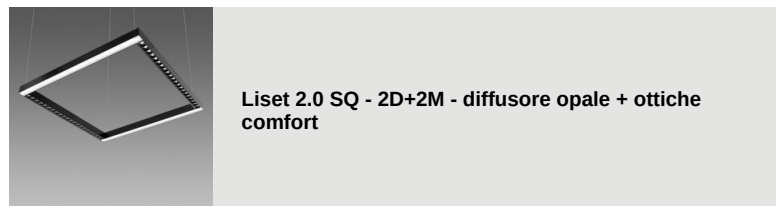
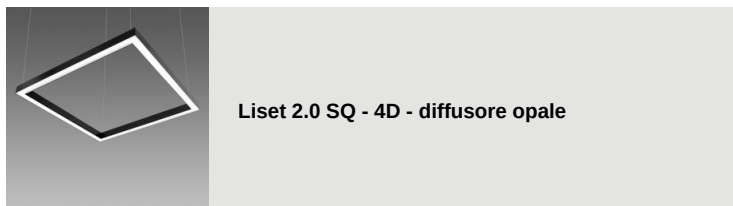
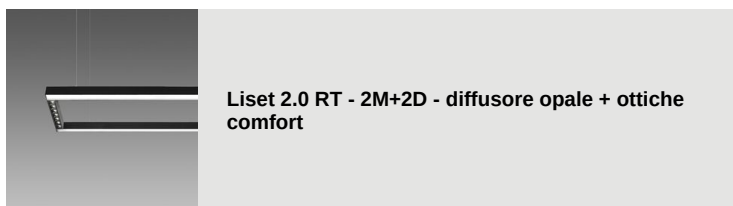
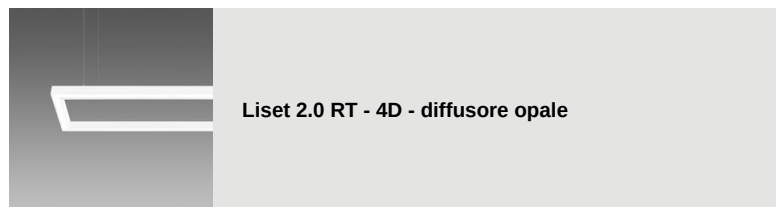
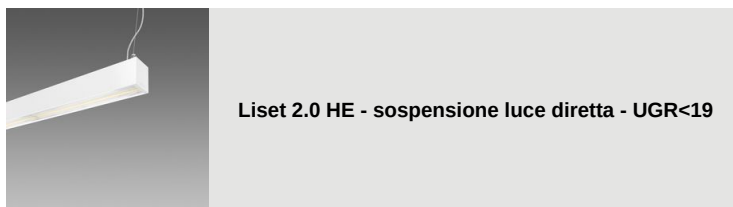
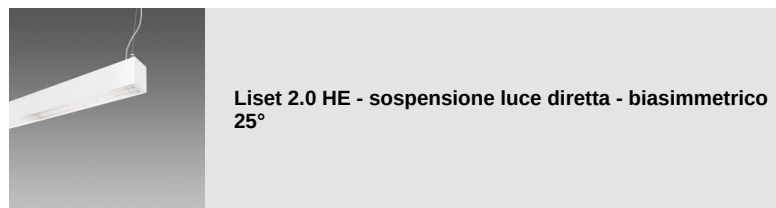
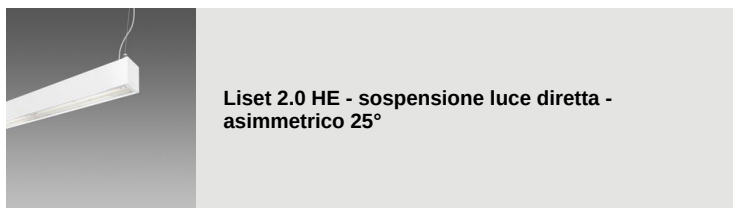





**Sintesi System - a sospensione con schermo satinato  
- UGR<22**



**Micro Liset - Cilindrica Professional**



**Liset 2.0 - a sospensione - diretta indiretta - ottiche  
comfort - UGR<19**



**Liset 2.0 - a sospensione - luce diretta indiretta - diffusore  
in policarbonato**



**Slim 3 URG<19**



**Sintesi System - a sospensione luce diretta indiretta -  
diffondente 60° - UGR<22**

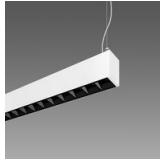

**Liset 2.0 TW - a sospensione - luce diretta - ottiche  
comfort - UGR<19**



**Liset 2.0 TW - a sospensione - luce diretta - diffusore in  
policarbonato**



**Sintesi System - a sospensione luce diretta indiretta -  
con schermo satinato - UGR<22**



**Sintesi System - a sospensione luce diretta indiretta - con  
schermo UGR<19**

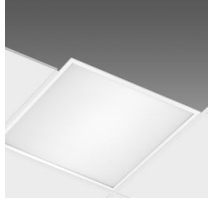

**PanelTech HP A2 - UGR<19-22**



**PanelTech A - UGR<19**



**PanelTech B - UGR<19**



**PanelTech R3 - UGR<19**



**PanelTech R2 - UGR<19**



**PanelTech HE A2 - UGR<19**



**PanelTech HE R2 - UGR<19**



**PanelTech HP R2 - UGR<19**



PanelTech A - UGR<19 - DIP SWITCH



PanelTech R2 - UGR<19 - DIP SWITCH



PanelTech HE R2 - UGR<19 - DIP SWITCH



PanelTech HE A2 - UGR<19 - DIP SWITCH



**fosnova** Omnitrack 3 accensioni



Omnitrack PLUS - 6 conduttori

5

Contattare il Centro di consulenza e progettazione per qualsiasi informazione illuminotecnica. Il flusso luminoso uscente riportato indica il flusso luminoso dell'apparecchio con una tolleranza di  $\pm 10\%$  rispetto al valore indicato. La potenza assorbita totale non supera il 10% del valore indicato. Le informazioni illuminotecniche possono essere soggette a variazioni e miglioramenti a causa della velocità della loro evoluzione tecnologica. Wednesday, February 14, 2024