

## Sospensione semplice

Codice: 22003171-00

### INFORMAZIONI GENERALI

|          |                      |
|----------|----------------------|
| Articolo | Sospensione semplice |
| Codice   | 22003171-00          |

### DIMENSIONI E PESO

|           |        |
|-----------|--------|
| Peso (Kg) | 0.2 kg |
|-----------|--------|



cavetto in acciaio (l=1,5m) con dispositivo per regolazione millimetrica. Carico max: 20 Kg.



## Sospensione semplice

---

Codice: 22003171-00



## Sospensione semplice

Codice: 22003171-00

### MATERIALI E COLORI

|       |   |
|-------|---|
| Corpo | cavetto in acciaio (l=1,5m) con dispositivo per regolazione millimetrica.<br>Carico max: 20 Kg. |
|-------|---|

|        |         |
|--------|---------|
| Colore | Argento |
|--------|---------|

### NORME E CONFORMITÀ

|                  |    |
|------------------|----|
| Marcature e test | CE |
|------------------|----|

### GARANZIA

|                       |      |
|-----------------------|------|
| Garanzia post-vendita | 0 yr |
|-----------------------|------|

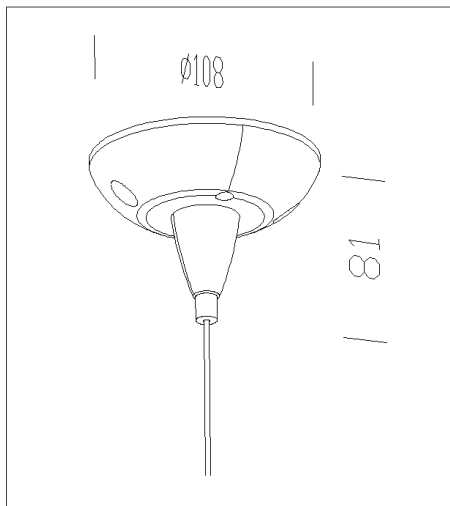

### DOWNLOAD

DISEGNI

DisegnoTecnico 3171.dxf



## Sospensione semplice

Codice: 22003171-00

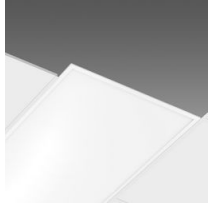

Eco Pannello luminoso R4



Sintesi System - a sospensione - diffondente



Sintesi System - a sospensione luce diretta indiretta - diffondente



Sintesi System - a sospensione luce diretta indiretta - ottica Dark - UGR<19



Sintesi System - a sospensione - con schermo UGR<19



Sintesi System - a sospensione - ottica Dark - UGR<19



Sintesi System - a sospensione con schermo satinato - UGR<22



Sintesi System - a sospensione luce diretta indiretta - diffondente 60° - UGR<22



Sintesi System - a sospensione luce diretta indiretta - con schermo satinato - UGR<22



Sintesi System - a sospensione luce diretta indiretta - con schermo UGR<19



PanelTech HP A2 - UGR<19-22



PanelTech A - UGR<19

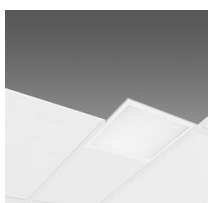

PanelTech B - UGR<19



PanelTech R3 - UGR<19

## Sospensione semplice

Codice: 22003171-00



PanelTech R2 - UGR<19



PanelTech HE A2 - UGR<19



PanelTech HE R2 - UGR<19



PanelTech HP R2 - UGR<19



PanelTech A - UGR<19 - DIP SWITCH



PanelTech R2 - UGR<19 - DIP SWITCH



PanelTech HE R2 - UGR<19 - DIP SWITCH



PanelTech HE A2 - UGR<19 - DIP SWITCH