

1477 - Palo Urban - con base

Codice: 425361-00

INFORMAZIONI GENERALI



Articolo	1477 - Palo Urban - con base
Codice	425361-00

DIMENSIONI E PESO

Peso (Kg)	48 kg
-----------	-------

INSTALLAZIONE

Diametro (Ø) attacco palo (mm)	60 - 60 mm
--------------------------------	------------

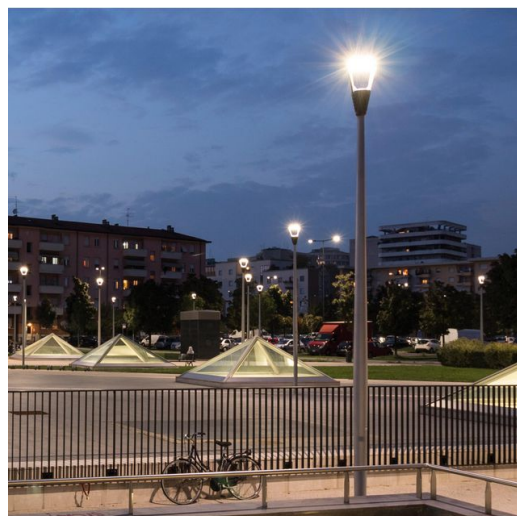

1477 Palo Urban - con base



1477 - Palo Urban - con base

Codice: 425361-00



1477 - Palo Urban - con base

Codice: 425361-00

MATERIALI E COLORI

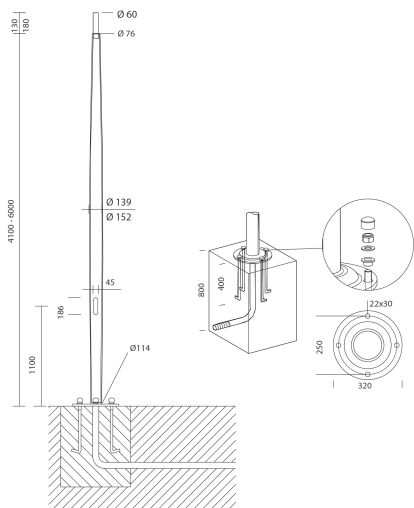

Corpo	In acciaio di sezione semicilindrica, completa di 2 fusibili da 16A, morsettiera asportabile. Per la versione con base è necessario acquistare 4 tirafondi. Predisposto con foro per ingresso cavo di alimentazione, con attacco testa palo Ø60.
Attacco palo	60 mm
Verniciatura	verniciato in polvere di poliestirene termoindurente.
Colore	Grafite

NORME E CONFORMITÀ

Marcature e test	CE
Test di laboratorio	La possibilità di accoppiare una composizione al palo è subordinata alla verifica della resistenza alla spinta del vento, nelle zone del territorio previsto dalla norma dal DM14/01/2008. Secondo le ipotesi di carico previsto dalle norme EN 40-3-1.

GARANZIA

Garanzia post-vendita	0 yr
-----------------------	------

DOWNLOAD

MONTAGGI

IstruzioniMontaggio 1440-1441-1477-1478 10-13.pdf

DISEGNI

DisegnoTecnico 1477v.dxf

DisegnoTecnico3D disano 1477 urban 6m.3ds



1477 - Palo Urban - con base

Codice: 425361-00

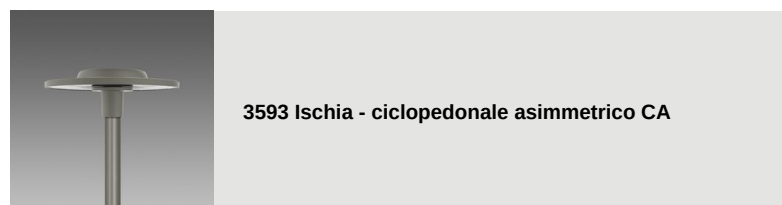
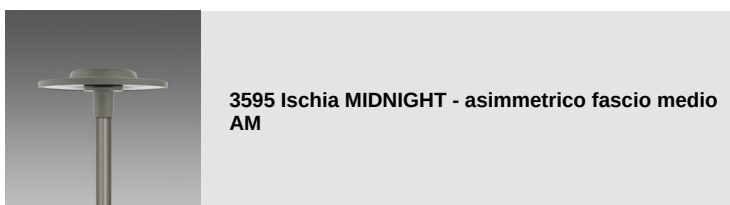
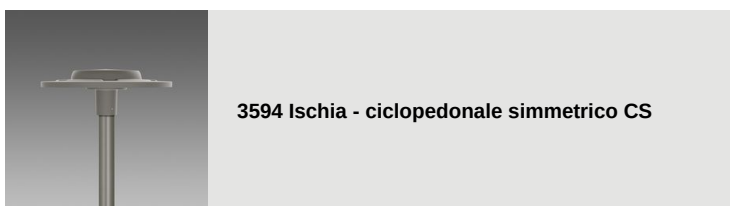
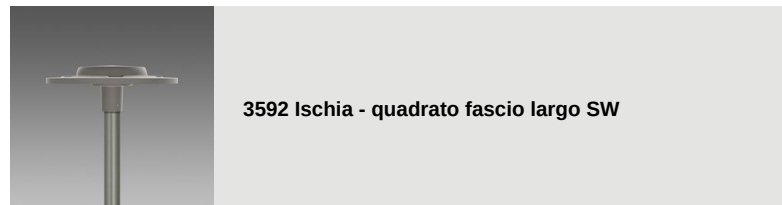
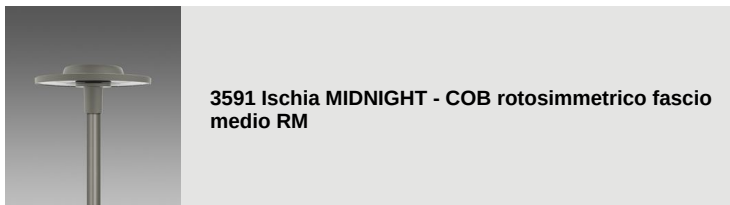
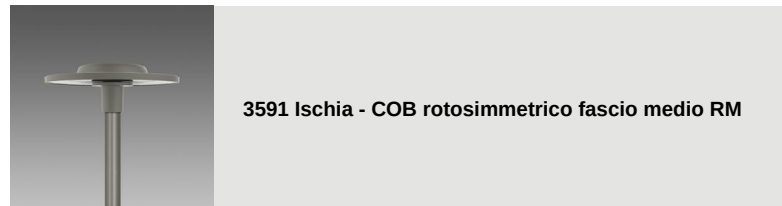

1477 - Palo Urban - con base

Codice: 425361-00



3593 Ischia MIDNIGHT - ciclopedonale asimmetrico CA



3596 Ischia - asimmetrico fascio largo AW



3595 Ischia - asimmetrico fascio medio AM



3360 Iseo 1 - rotosimmetrico



3361 Iseo 2 - stradale



3362 Iseo 3 - centro strada



3363 Iseo 4 - ciclabile

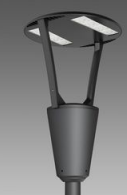

3383 Como 1 - rotosimmetrico



3384 Como 2 - asimmetrico

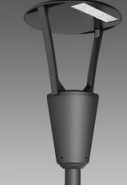

3385 Como 3 - ciclabile



3386 Como 4 - bi-asimmetrico



3350 Garda 1 - rotosimmetrico



3351 Garda 2 - asimmetrico



3352 Garda 3 - ciclabile



3353 Garda 4 - ciclabile + stradale



3355 Garda 5 - rotosimmetrico



3355 Garda 6 - rotosimmetrico



3340 Loto 1 - diffondente trasparente



3340 Loto 2 - diffondente satinato



3342 Loto 3 - asimmetrico



3343 Loto 4 - ciclabile



3344 Loto 5 - diffondente



3345 Loto 6 - COB



3345 Loto 6 - MIDNIGHT COB



3331 Disco 2 - diffondente



3334 Disco 5 - attacco centrale



3336 Visconti 2.0 - rotosimmetrico



3337 Visconti 2.0 - stradale ME



3338 Visconti 2.0 - ciclabile



3339 Visconti 2.0 - grandi aree



3580 Volo - stradale - High Performance



3581 Volo - ciclabile + stradale



3582 Volo - ciclabile



3583 Volo - rotosimmetrico



3290 Sella 1 - ST



3291 Sella 1 - STWB



3292 Sella 1 - asimmetrico 45°



3293 Sella 1 - asimmetrico 60°



3294 Sella 1 - piste ciclabili



3295 Sella 1 - grandi aree



3296 Sella 1 - HP



3297 Sella 1 - HP -attraversamenti pedonali SX



3298 Sella 1 - HP -attraversamenti pedonali DX



3390 Sella 2 - ST



3391 Sella 2 - STWB



3392 Sella 2 - asimmetrico 45°



3393 Sella 2 - asimmetrico 60°



3395 Sella 2 - grandi aree



3396 Sella 2 - HP



3476 Mini Giovi W2 - stradale

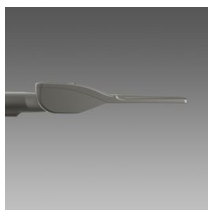

3477 Mini Giovi N1 - ciclabile



3478 Mini Giovi M1 - stradale



3479 Mini Giovi T4 - grandi aree



3480 Mini Giovi - high performance - grandi aree

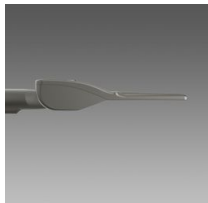

3481 Mini Giovi - high performance - stradale ME



3482 Mini Giovi - high performance - ciclabile



3483 Mini Giovi AMBRA - grandi aree



3484 Mini Giovi AMBRA - stradale ME



3485 Mini Giovi AMBRA - ciclabile



3486 Mini Giovi sinistro (SX)-attraversamenti pedonali



3487 Mini Giovi destro (DX)-attraversamenti pedonali



3472 Giovi M1 - stradale



3473 Giovi W1 - stradale



3474 Giovi M2 - stradale



3490 Giovi - high performance - grandi aree



3491 Giovi - high performance - stradale ME



3492 Giovi AMBRA T4 - grandi aree



3493 Giovi AMBRA - stradale ME



3494 Giovi T4 - asimmetrico - grandi aree



3495 Giovi W2 - stradale



3496 Giovi - sinistro (SX)-attraversamenti pedonali



3497 Giovi - destro (DX)-attraversamenti pedonali



3269 Mini Stelvio FX T5 - diffondente



3277 Mini Stelvio FX T2 - stradale



3278 Mini Stelvio FX T3 - diffondente stradale



3279 Mini Stelvio FX T4 - asimmetrico



3375 Mini Stelvio - high performance - stradale



3376 Mini Stelvio - high performance - grandi aree



3270 Stelvio 1 - Plus - LED



3274 Stelvio 2 - Plus - LED asimmetrico



3370 Stelvio - high performance - stradale



3374 Stelvio - high performance - grandi aree



1518 Clima LED anti-inquinamento luminoso



1570 Clima - LED



1513 Torcia LED COB



1707 Torcia LED