

## 1477 - Palo Urban - con base

Codice: 425363-00

### INFORMAZIONI GENERALI



Articolo	1477 - Palo Urban - con base
Codice	425363-00

### DIMENSIONI E PESO

Peso (Kg)	64 kg
-----------	-------

### INSTALLAZIONE

Diametro (Ø) attacco palo (mm)	60 - 60 mm
--------------------------------	------------

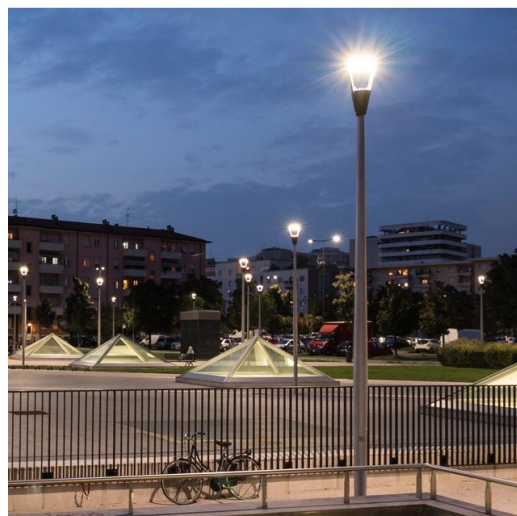

1477 Palo Urban - con base



## 1477 - Palo Urban - con base

---

Codice: 425363-00



## 1477 - Palo Urban - con base

Codice: 425363-00

### MATERIALI E COLORI

Corpo	In acciaio di sezione semicilindrica. completa di 2 fusibili da 16A, morsettiera asportabile. Per la versione con base è necessario acquistare 4 tirafondi. Predisposto con foro per ingresso cavo di alimentazione, con attacco testa palo $\varnothing 60$ .
Attacco palo	60 mm
Verniciatura	verniciato in polvere di poliestirene termoindurente.
Colore	Grey

### NORME E CONFORMITÀ

Marcature e test	CE
Test di laboratorio	La possibilità di accoppiare una composizione al palo è subordinata alla verifica della resistenza alla spinta del vento, nelle zone del territorio previsto dalla norma dal DM14/01/2008. Secondo le ipotesi di carico previsto dalle norme EN 40-3-1.

### GARANZIA

Garanzia post-vendita	0 yr
-----------------------	------

### DOWNLOAD

#### MONTAGGI

IstruzioniMontaggio 1440-1441-1477-1478 10-13.pdf

#### DISEGNI

DisegnoTecnico 1477v.dxf

DisegnoTecnico3D disano 1477 urban 6m.3ds

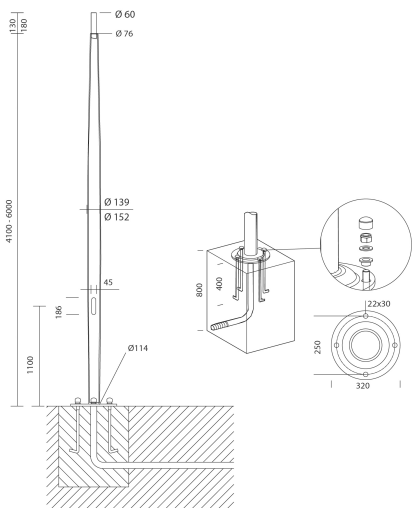

## 1477 - Palo Urban - con base

Codice: 425363-00

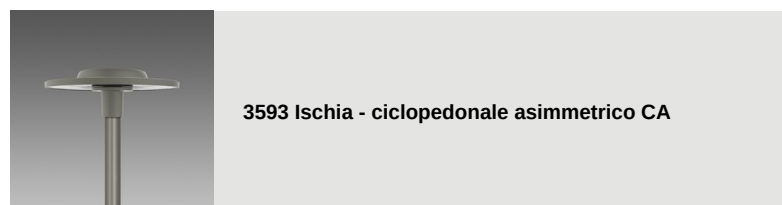
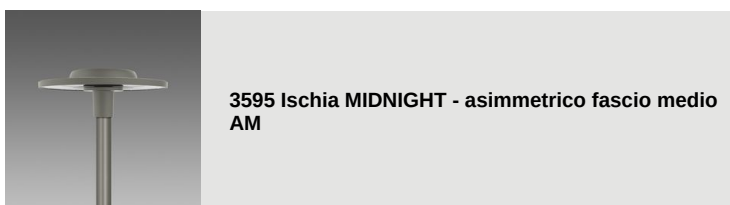
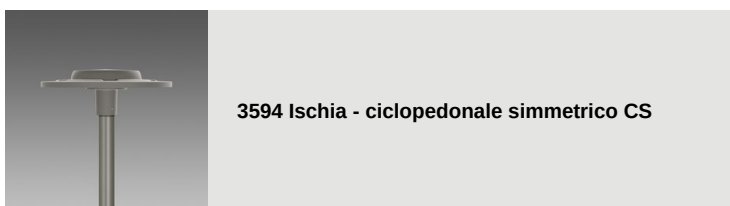
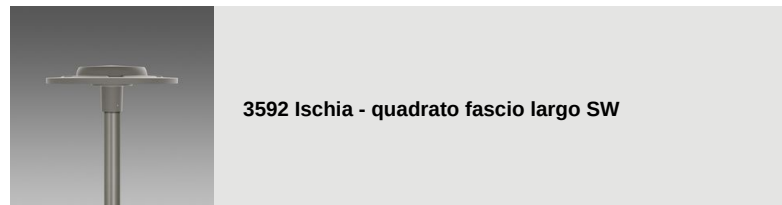
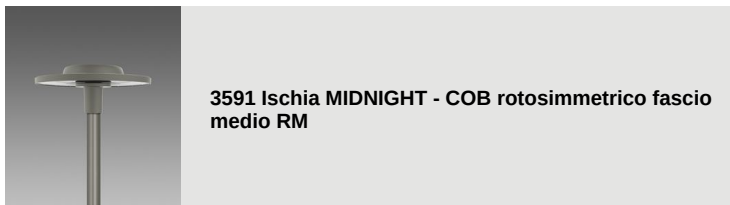
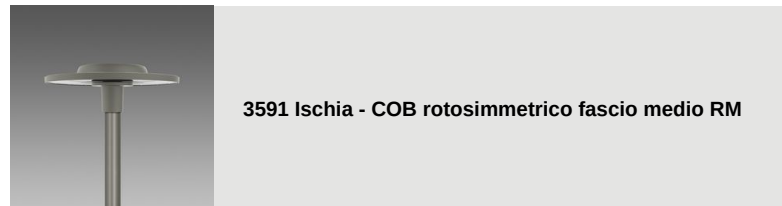

## 1477 - Palo Urban - con base

Codice: 425363-00



**3593 Ischia MIDNIGHT - ciclopedonale asimmetrico CA**



**3596 Ischia - asimmetrico fascio largo AW**



**3595 Ischia - asimmetrico fascio medio AM**



**3360 Iseo 1 - rotosimmetrico**



**3361 Iseo 2 - stradale**



**3362 Iseo 3 - centro strada**

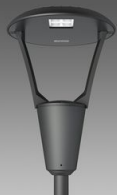

**3363 Iseo 4 - ciclabile**

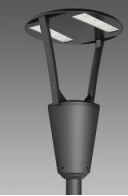

**3383 Como 1 - rotosimmetrico**



**3384 Como 2 - asimmetrico**



**3385 Como 3 - ciclabile**



**3386 Como 4 - bi-asimmetrico**



**3350 Garda 1 - rotosimmetrico**



**3351 Garda 2 - asimmetrico**



**3352 Garda 3 - ciclabile**



**3353 Garda 4 - ciclabile + stradale**



**3355 Garda 5 - rotosimmetrico**



**3355 Garda 6 - rotosimmetrico**



**3340 Loto 1 - diffondente trasparente**



**3340 Loto 2 - diffondente satinato**



**3342 Loto 3 - asimmetrico**



**3343 Loto 4 - ciclabile**



**3344 Loto 5 - diffondente**



**3345 Loto 6 - COB**



**3345 Loto 6 - MIDNIGHT COB**



**3331 Disco 2 - diffondente**



**3334 Disco 5 - attacco centrale**



**3336 Visconti 2.0 - rotosimmetrico**



**3337 Visconti 2.0 - stradale ME**



**3338 Visconti 2.0 - ciclabile**



**3339 Visconti 2.0 - grandi aree**



**3580 Volo - stradale - High Performance**



**3581 Volo - ciclabile + stradale**



**3582 Volo - ciclabile**



**3583 Volo - rotosimmetrico**



**3290 Sella 1 - ST**



**3291 Sella 1 - STWB**



**3292 Sella 1 - asimmetrico 45°**



**3293 Sella 1 - asimmetrico 60°**



**3294 Sella 1 - piste ciclabili**



**3295 Sella 1 - grandi aree**



**3296 Sella 1 - HP**



**3297 Sella 1 - HP -attraversamenti pedonali SX**



**3298 Sella 1 - HP -attraversamenti pedonali DX**



**3390 Sella 2 - ST**



**3391 Sella 2 - STWB**



**3392 Sella 2 - asimmetrico 45°**



**3393 Sella 2 - asimmetrico 60°**



**3395 Sella 2 - grandi aree**



**3396 Sella 2 - HP**



**3476 Mini Giovi W2 - stradale**

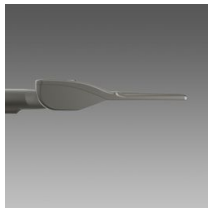

**3477 Mini Giovi N1 - ciclabile**



**3478 Mini Giovi M1 - stradale**



3479 Mini Giovi T4 - grandi aree



3480 Mini Giovi - high performance - grandi aree

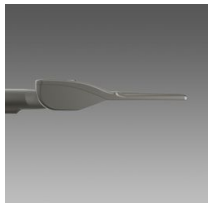

3481 Mini Giovi - high performance - stradale ME



3482 Mini Giovi - high performance - ciclabile



3483 Mini Giovi AMBRA - grandi aree



3484 Mini Giovi AMBRA - stradale ME



3485 Mini Giovi AMBRA - ciclabile



3486 Mini Giovi sinistro (SX)-attraversamenti pedonali



3487 Mini Giovi destro (DX)-attraversamenti pedonali



3472 Giovi M1 - stradale



3473 Giovi W1 - stradale



3474 Giovi M2 - stradale



3490 Giovi - high performance - grandi aree



3491 Giovi - high performance - stradale ME



3492 Giovi AMBRA T4 - grandi aree



3493 Giovi AMBRA - stradale ME



3494 Giovi T4 - asimmetrico - grandi aree



3495 Giovi W2 - stradale





3496 Giovi - sinistro (SX)-attraversamenti pedonali



3497 Giovi - destro (DX)-attraversamenti pedonali



3269 Mini Stelvio FX T5 - diffondente



3277 Mini Stelvio FX T2 - stradale



3278 Mini Stelvio FX T3 - diffondente stradale



3279 Mini Stelvio FX T4 - asimmetrico



3375 Mini Stelvio - high performance - stradale



3376 Mini Stelvio - high performance - grandi aree



3270 Stelvio 1 - Plus - LED



3274 Stelvio 2 - Plus - LED asimmetrico



3370 Stelvio - high performance - stradale



3374 Stelvio - high performance - grandi aree



1518 Klima LED anti-inquinamento luminoso



1570 Klima - LED



1513 Torcia LED COB



1707 Torcia LED