

## 504 - Braccio singolo

Codice: 991262-00

### INFORMAZIONI GENERALI

Articolo	504 - Braccio singolo
Codice	991262-00

### DIMENSIONI E PESO

Lunghezza (mm)	900 mm
Larghezza (mm)	100 mm
Peso (Kg)	8.5 kg

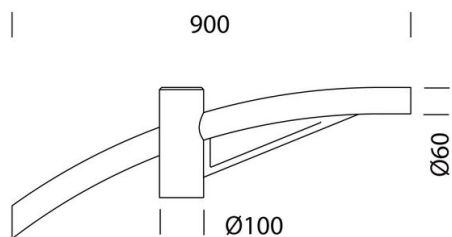

504 Braccio singolo



## 504 - Braccio singolo

---

Codice: 991262-00



## 504 - Braccio singolo

Codice: 991262-00

### MATERIALI E COLORI

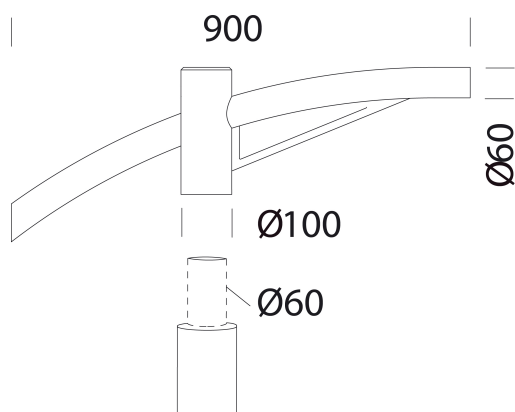

Corpo in acciaio, idoneo per l'installazione su pali con attacco Ø60.

Attacco palo 60 mm

Colore Grey9007

### GARANZIA

Garanzia post-vendita 0 yr

### DOWNLOAD

DISEGNI

DisegnoTecnico 504k.dxf



## 504 - Braccio singolo

Codice: 991262-00



3472 Giovi M1 - stradale



3269 Mini Stelvio FX T5 - diffondente



3278 Mini Stelvio FX T3 - diffondente stradale



3376 Mini Stelvio - high performance - grandi aree



3285 Rolle - high performance



3286 Rolle - high performance



3476 Mini Giovi W2 - stradale

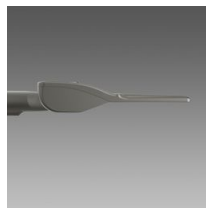

3477 Mini Giovi N1 - ciclabile



3478 Mini Giovi M1 - stradale



3479 Mini Giovi T4 - grandi aree



3480 Mini Giovi - high performance - grandi aree

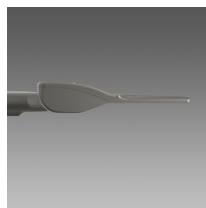

3481 Mini Giovi - high performance - stradale ME

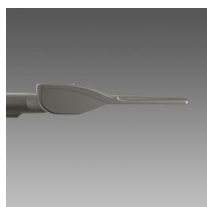

3482 Mini Giovi - high performance - ciclabile

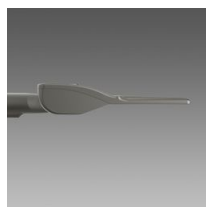

3483 Mini Giovi AMBRA - grandi aree

## 504 - Braccio singolo

Codice: 991262-00

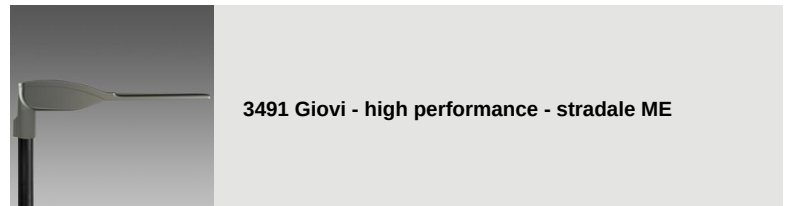
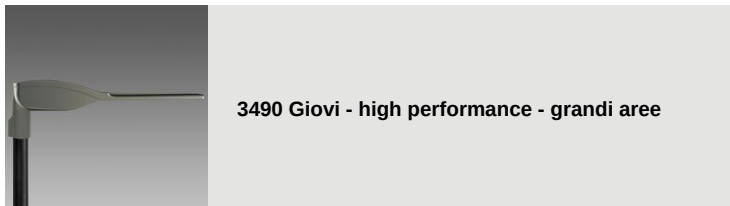
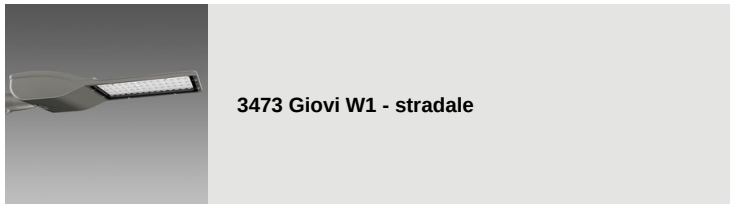



**3375 Mini Stelvio - high performance - stradale**



**3280 Rolle - T1**

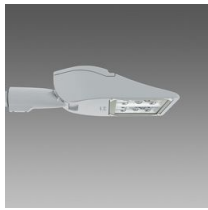

**3283 Rolle - T4**



**3284 Rolle - T5**



**3290 Sella 1 - ST**



**3291 Sella 1 - STWB**



**3292 Sella 1 - asimmetrico 45°**



**3293 Sella 1 - asimmetrico 60°**



**3294 Sella 1 - piste ciclabili**



**3295 Sella 1 - grandi aree**



**3296 Sella 1 - HP**



**3297 Sella 1 - HP -attraversamenti pedonali SX**



**3298 Sella 1 - HP -attraversamenti pedonali DX**



**3390 Sella 2 - ST**



**3391 Sella 2 - STWB**



**3392 Sella 2 - asimmetrico 45°**



**3393 Sella 2 - asimmetrico 60°**



**3395 Sella 2 - grandi aree**



3396 Sella 2 - HP



3270 Stelvio 1 - Plus - LED



3274 Stelvio 2 - Plus - LED asimmetrico



3370 Stelvio - high performance - stradale



3374 Stelvio - high performance - grandi aree



3475 Mini Giovi W1 - stradale



3275 Mini Stelvio - stradale



3276 Mini Stelvio - asimmetrico



3281 Rolle - T2



3282 Rolle - T3

Contattare il Centro di consulenza e progettazione per qualsiasi informazione illuminotecnica. Il flusso luminoso uscente riportato indica il flusso luminoso dell'apparecchio con una tolleranza di  $\pm 10\%$  rispetto al valore indicato. La potenza assorbita totale non supera il 10% del valore indicato. Le informazioni illuminotecniche possono essere soggette a variazioni e miglioramenti a causa della velocità della loro evoluzione tecnologica. Thursday, July 4, 2024