

508 - Braccio doppio

Codice: 991266-00

INFORMAZIONI GENERALI

Articolo	508 - Braccio doppio
Codice	991266-00

DIMENSIONI E PESO

Lunghezza (mm)	1040 mm
Larghezza (mm)	100 mm
Altezza (mm)	350 mm
Peso (Kg)	9 kg

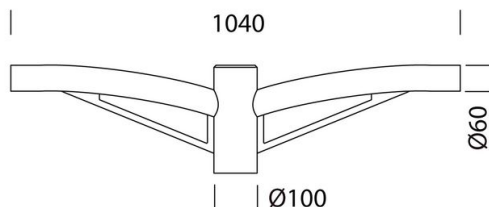

in acciaio, idoneo per l'installazione su pali con attacco Ø60.



508 - Braccio doppio

Codice: 991266-00



508 - Braccio doppio

Codice: 991266-00

MATERIALI E COLORI

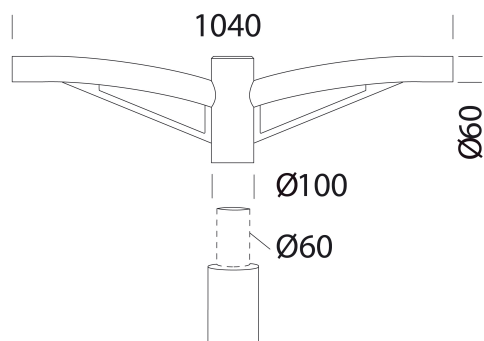

Corpo	in acciaio, idoneo per l'installazione su pali con attacco Ø60.
Attacco palo	60 mm
Colore	Grey9007

GARANZIA

Garanzia post-vendita	0 yr
-----------------------	------

DOWNLOAD

DISEGNI

DisegnoTecnico 508.dxf



508 - Braccio doppio

Codice: 991266-00



3472 Giovi M1 - stradale



3269 Mini Stelvio FX T5 - diffondente



3278 Mini Stelvio FX T3 - diffondente stradale



3376 Mini Stelvio - high performance - grandi aree



3285 Rolle - high performance



3286 Rolle - high performance



3476 Mini Giovi W2 - stradale

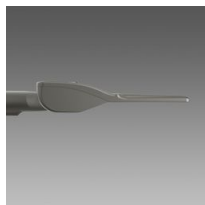

3477 Mini Giovi N1 - ciclabile



3478 Mini Giovi M1 - stradale



3479 Mini Giovi T4 - grandi aree



3480 Mini Giovi - high performance - grandi aree

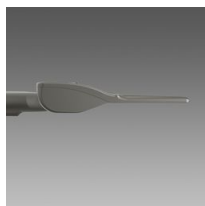

3481 Mini Giovi - high performance - stradale ME

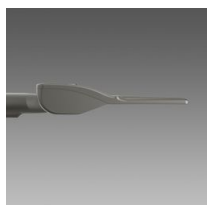

3482 Mini Giovi - high performance - ciclabile

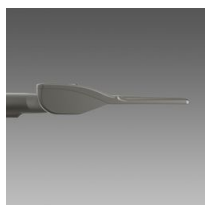

3483 Mini Giovi AMBRA - grandi aree

508 - Braccio doppio

Codice: 991266-00

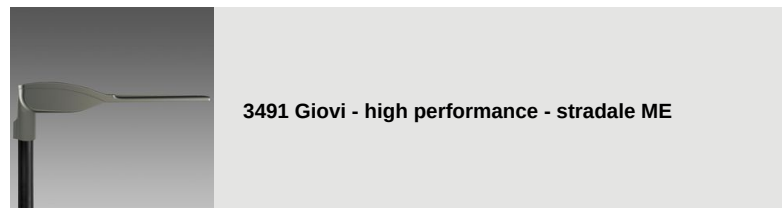
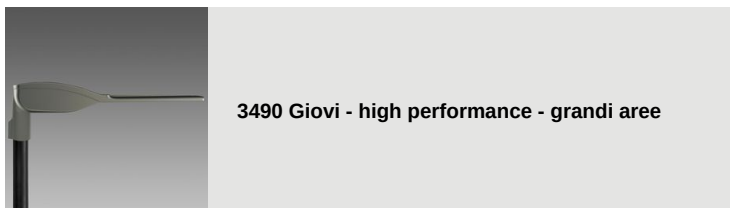



3375 Mini Stelvio - high performance - stradale



3280 Rolle - T1

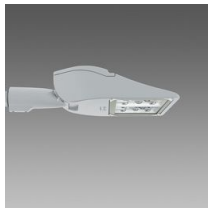

3283 Rolle - T4



3284 Rolle - T5



3290 Sella 1 - ST



3291 Sella 1 - STWB



3292 Sella 1 - asimmetrico 45°



3293 Sella 1 - asimmetrico 60°



3294 Sella 1 - piste ciclabili



3295 Sella 1 - grandi aree



3296 Sella 1 - HP



3297 Sella 1 - HP -attraversamenti pedonali SX



3298 Sella 1 - HP -attraversamenti pedonali DX



3390 Sella 2 - ST



3391 Sella 2 - STWB



3392 Sella 2 - asimmetrico 45°



3393 Sella 2 - asimmetrico 60°



3395 Sella 2 - grandi aree



3396 Sella 2 - HP



3270 Stelvio 1 - Plus - LED



3274 Stelvio 2 - Plus - LED asimmetrico



3370 Stelvio - high performance - stradale



3374 Stelvio - high performance - grandi aree



3475 Mini Giovi W1 - stradale



3275 Mini Stelvio - stradale



3276 Mini Stelvio - asimmetrico



3281 Rolle - T2



3282 Rolle - T3



Contattare il Centro di consulenza e progettazione per qualsiasi informazione illuminotecnica. Il flusso luminoso uscente riportato indica il flusso luminoso dell'apparecchio con una tolleranza di $\pm 10\%$ rispetto al valore indicato. La potenza assorbita totale non supera il 10% del valore indicato. Le informazioni illuminotecniche possono essere soggette a variazioni e miglioramenti a causa della velocità della loro evoluzione tecnologica. Thursday, October 24, 2024